



# High Performance Pneumatic Valves Viking Xtreme Series

G1/8- G1/2 body ported

Catalogue PDE2569TCUK - September 2015

aerospace  
climate control  
electromechanical  
filtration  
fluid & gas handling  
hydraulics  
**pneumatics**  
process control  
sealing & shielding



ENGINEERING YOUR SUCCESS.





Material Specification.....	7
Flow Characteristics.....	8
Order Key - Viking Xtreme Air Pilot & Manual Valves.....	9
Main Data Pneumatic + Manually Operated Valves.....	10 - 13
Order Key - Normal Operating Pressure.....	14
Main Data Electrically Actuated Directional Control Valves Normal .....	15 - 20
Order Key - Viking Xtreme Valves.....	21
Main Data Electrically Actuated Directional Control Valves Xtreme.....	22 - 24
Dimensions - P2LAX / P2LBX / P2LCX / P2LDX.....	25 - 48
P2LA, Flexible Manifold Assembly .....	49
P2LA, Accessorie Order Codes .....	50 - 54
Manifold Dimensions.....	51 - 54
Solenoid Valves - 15mm.....	55
Solenoid Valves Order Key - 15mm.....	56
Solenoid Valves Technical Data - 15mm.....	57
Solenoid Valves - 22mm.....	58
Solenoid Valves Order Key - 22mm.....	59
Solenoid Valves Technical Data - 22mm.....	60 - 61
Solenoid Connectors + Cable Plugs.....	62 - 63
Service and Replacement Parts.....	63

**Important !**



Before carrying out any service work, ensure that the valve and manifold have been vented. Remove the primary supply air hose to ensure total disconnection of the air supply before dismantling valves or blank connection blocks.

**NB !**



All technical data in this catalogue is typical only. The air quality is decisive for the valve life: see ISO 8573.

 **WARNING**

FAILURE OR IMPROPER SELECTION OR IMPROPER USE OF THE PRODUCTS AND/OR SYSTEMS DESCRIBED HEREIN OR RELATED ITEMS CAN CAUSE DEATH, PERSONAL INJURY AND PROPERTY DAMAGE.

This document and other information from Parker Hannifin Corporation, its subsidiaries and authorized distributors provide product and/or system options for further investigation by users having technical expertise. It is important that you analyze all aspects of your application and review the information concerning the product or system in the current product catalog. Due to the variety of operating conditions and applications for these products or systems, the user, through its own analysis and testing, is solely responsible for making the final selection of the products and systems and assuring that all performance, safety and warning requirements of the application are met. The products described herein, including without limitation, product features, specifications, designs, availability and pricing, are subject to change by Parker Hannifin Corporation and its subsidiaries at any time without notice.

**SALE CONDITIONS**

*The items described in this document are available for sale by Parker Hannifin Corporation, its subsidiaries or its authorized distributors. Any sale contract entered into by Parker will be governed by the provisions stated in Parker's standard terms and conditions of sale (copy available upon request).*



# Extreme Environments Demand The Viking Xtreme



The Viking Xtreme valve range is robust, versatile and combines high performance with compact installation dimensions. Large flow capacity, short change-over times and low change-over pressure are important characteristics of this valve range.

The 1/8 & 1/4 sizes are designed to operate with pressures up to 16 bar and the 3/8 & 1/2 sizes up to 12 bar, in ambient temperatures -40°C to + 60°C when fitted with suitable solenoid operators.

## Viking Xtreme range

**P2LAX, dimension G1/8**  
**P2LBX, dimension G1/4**  
**P2LCX, dimension G3/8**  
**P2LDX, dimension G1/2**

Wide range of 3/2, 5/2 and 5/3 valves for manual, pneumatic or electric operation

Pilot chamber breathers are protected against ingress of dust and dirt.

Robust valve anodised aluminium valve body. The bore is polished to a very high surface finish for maximum flow capacity and long life.

Aluminium spool with nitrile rubber coating, ground to exact size for optimum performance.

Stainless steel end cover screws resist aggressive environments.

Diecast end covers

## Over-moulded single piece aluminium spool

- Reduced product complexity
- Increased flow
- Wide operating temperature range.
- Stable seal performance even with high flow/pressure drop across spool.

Nitrile overmoulding

Precision ground for maximum performance

## Manually operated range

The complete range includes lever operated versions. They feature a rugged hand lever specifically designed for gloved hands and are available in 3/2, 5/2 and 5/3 functions



# Whatever the environment, Push it to the Xtreme



## Compact installation dimensions - flexible installation

Compact dimensions direct body porting and integral mounting holes are all features of the Viking Xtreme range. In addition to single valve installation, the Viking valve may be installed on manifolds so that the valves have a common supply and manifolded exhausts.

## Mobile applications

The Viking Xtreme valves have a robust body which is machined out of solid aluminium bar and then anodised. Valves have passed aggressive salt spray, and demanding vibration tests and will operate in ambient temperatures of  $-40^{\circ}\text{C}$  to  $+60^{\circ}\text{C}$ . Solenoids are available having wide voltage tolerance for mobile applications.

## Maintenance

The Viking Xtreme valve range has been developed from the very successful VGD15 and P2L-A product ranges which have a history of reliable and long service life in demanding and difficult applications. Spares kits are available for the valve and solenoid operators.

## Manually operated versions

The range has now been extended to include lever operated versions. The rugged lever actuator has been specifically designed for gloved hands to suit mobile applications in the most arduous of environments.

Available in 3/2, 5/2 and 5/3 functions with either spring return or detented lever and with a choice of mid position function in the 5/3 versions. The lever actuated versions are available across the entire range of port sizes G1/8, G1/4, G3/8 and G1/2.

## High reliability

Valves easily comply with the requirements for the component reliability in accordance with EU Machinery Directive standards EN292-2 and EN983. The valves have passed shocks & vibrations test IEC6173: 1999 cat 1 class B

The Viking Xtreme valves have few moving parts combined with short spool movement, these features combine to give valves having high reliability and long service life. The valves are designed for use with or without supplementary lubrication.

## Rust and corrosion resistant designs.

Viking valves are made entirely of anodized aluminium, for good corrosion resistance. The smooth design, with no dirt-collecting pockets, makes the valve suitable for most environments, including applications with stringent hygiene requirements. The valve has stainless steel fixing screws for the end covers, to withstand aggressive environments.

## Insensitive to dirty air

Thanks to large flow passage areas and the large flow diameter of 1.0 in the pilot valves, the P2LA and P2LB can be used in normal industrial or mobile environments without any problems of blocking. However the service life of the valve depends on the cleanliness of the air. Please refer to ISO 8573. Valves having ATEX approval  
ATEX approved options are available for use in explosive atmospheres. Consult our Technical Sales Department for further information.

## Complete range

Manual, pneumatic, electric, 3/2, 5/2 & 5/3; the Viking Xtreme valve range is suitable for a multiple application. For mobile or industrial applications, all functions are available from G1/8 to G1/2 using the same design and technology



Road

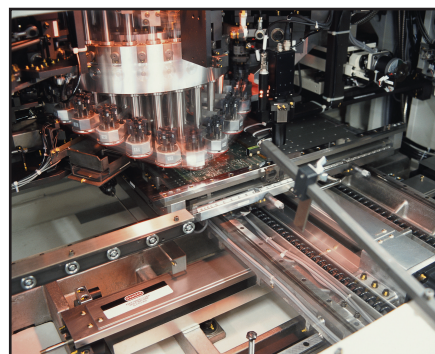

Industrial



Oil &amp; Gas







#### Flexible multiple installation

There is a system of multiple installation plates, intermediate blocks and several variants of connectors for the P2LA. Several variants of connectors are available, which permit connection from above, beneath, straight from the side or in the middle of a valve block. Using the type L manifold, valve blocks may be constructed for supplying several different pressures.

#### Manifold bar installation

A manifold bar, with common ducts for ports 1, 3 and 5 gives simple, time saving and easily serviced installation. Manifold bars are available in several different sizes, with space for between 2 and 14 valves. They are designed for simple handling and are entirely serviced from the front.

#### Pressure bar installation

A pressure bar for common primary air supply gives a simple, robust, time saving and easily serviced installation. When pressure bars are used, restrictor-silencers can be installed in the exhaust ports of each valve, for individual adjustment of cylinder/air motor speed. Pressure bars are available in a number of different sizes, with space ranging from 2 to 10 valves.



Rail



Agri-Food



Forestry

**Working medium, air quality**

Working medium: Dry, filtered compressed air to ISO 8573-1 class 3.4.3.

**Recommended air quality for valves**

For best possible service life and trouble free operation, ISO 8573-1 quality class 3.4.3 should be used. This means 5µm filter (standard filter) dew point +3°C for indoor operation (a lower dew point should be selected for outdoor operation) and oil concentration 1.0 mg oil/m<sup>3</sup>, which is what a standard compressor with a standard filter gives.

**ISO 8573-1 quality classes**

Quality class	Pollution		Water max. press. dew point (°C)	Oil max. concentration (mg/m <sup>3</sup> )
	particle size (µm)	max. concentration (mg/m <sup>3</sup> )		
1	0,1	0,1	-70	0,01
2	1	1	-40	0,1
3	5	5	-20	1,0
4	15	8	+3	5,0
5	40	10	+7	25
6	-	-	+10	-

**Typical cylinders speeds which can be achieved with Viking valves and different tube sizes.**

In the chart below you can find the suitable valves, tubes etc. for each cylinder size. If you have a tube length over 2 m, choose one tube size larger than in the chart.

Following data is valid:

- Supply pressure : min 7,0 bar
- Regulator pressure setting : 6,0 bar
- Pipe length between air treatment unit and valve : max 1 m
- Pipe length between valve and cylinder : max 2 m

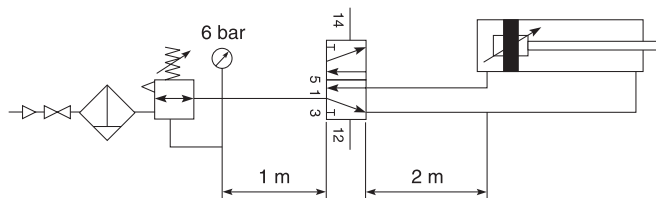

Cylinder bore	<20	20-32	40-50	63	80	100	125	160	200
Cylinder port	M5	G1/8	G1/4	G3/8	G3/8	G1/2	G1/2	G3/4	G3/4
Tubing Ext/Int	4/2.7	6/4	8/6	10/8	10/8	12/9	14/11	18/15	20/18
			6/4	8/6	12/9	14/11			
P2LAX	G1/8	G1/8	G1/8	G1/8	G1/8				
P2LBX	G1/4	G1/4	G1/4	G1/4	G1/4	G1/4			
P2LCX			G3/8	G3/8	G3/8	G3/8	G3/8		
P2LDX				G1/2	G1/2	G1/2	G1/2	G1/2	G1/2

Cylinder speed < 0,5 m/s    
  Cylinder speed < 1 m/s  
 Oversized    
  Cylinder speed > 1 m/s





## Material specification

### P2LAX

#### Valve

Valve body	Anodised aluminium
End covers	Anodised aluminium
Lever housing	Acetal plastic
Spool	Aluminium + nitrile rubber
Piston	Acetal plastic/ Anodised aluminium
End cover sealings	Nitrile rubber
End cover screws	Stainless steel
Springs	Dacromet® - processed steel, Stainless steel
Lever	Reinforced polyamid plastic
Panel mounting nut	Polycarbonate plastic
Gaiter	Chloroprene rubber
Mounting screws for solenoid	Stainless steel

#### Accessories

Manifold bar	Anodised aluminium
Pressure bar	Anodised aluminium
Multiple manifolds	Anodised aluminium
End and intermediate blocks	Anodised aluminium

### P2LBX

#### Valve

Valve body	Anodised aluminium
End covers	Anodised aluminium
Lever housing	Anodised aluminium
Spool	Aluminium + nitrile rubber
Piston	Acetal plastic/ Anodised aluminium
End cover sealings	Nitrile rubber
End cover screws	Stainless steel
Springs	Dacromet® - processed steel, Stainless steel
Lever	Steel Zinc Plated
Gaiter	Chloroprene rubber
Mounting screws for solenoid	Stainless steel
Panel Washer	Nitrile
Twist Bush	Acetal
Helix Bush	Brass
Pin	Plated Steel
Twist Housing	Anodised Aluminium
Twist Knob	Polyamide 6
Panel mounting ring	Acetal
Lever Housings	Anodised Aluminium
Lever selector	Zinc Diecast

#### Accessories

Manifold bar	Anodised aluminium
Pressure bar	Anodised aluminium

### P2LCX

#### Valve

Valve body	Anodised aluminium
End covers	Anodised aluminium
Spool	Aluminium + nitrile rubber
Piston	Acetal plastic/ Anodised aluminium
End cover sealings	Nitrile rubber
End cover screws	Stainless steel
Springs	Dacromet® - processed steel, Stainless steel
Lever	Steel Zinc Plated
Gaiter	Chloroprene rubber
Mounting screws for solenoid	Stainless steel

### P2LDX

#### Valve

Valve body	Anodised aluminium
End covers	Anodised aluminium
Spool	Aluminium + nitrile rubber
Piston	Acetal plastic/ Anodised aluminium
End cover sealings	Nitrile rubber
End cover screws	Stainless steel
Springs	Dacromet® - processed steel, Stainless steel
Lever	Steel Zinc Plated
Gaiter	Chloroprene rubber
Mounting screws for solenoid	Stainless steel

**Flow characteristics**

Flow capacities in accordance with ISO6358  
 All pressures = effective pressure  
 The curves in the diagram below are typical only

**Technical Data P2LAX**

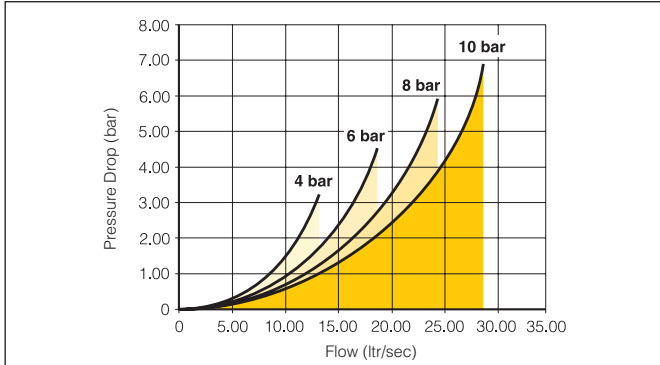

Port size	G1/8
Max operating pressure.	16 bar
Working temperature.	
Air pilot lever solenoid.	-40°C to + 60°C
Air pilot solenoid.	-10°C to + 50°C
Standard and food version.	-40°C to + 60°C
Mobile version.	-40°C to + 60°C
Flow (acc. to ISO 6358)	$c = 3,0 \text{ NI/s} \times \text{bar}$ $b = 0,2$ $Q_n = 11,0 \text{ l/s}$ $Q_{max} = 19,0 \text{ l/s}$ $C_v = 0,65$

**Technical Data P2LBX**

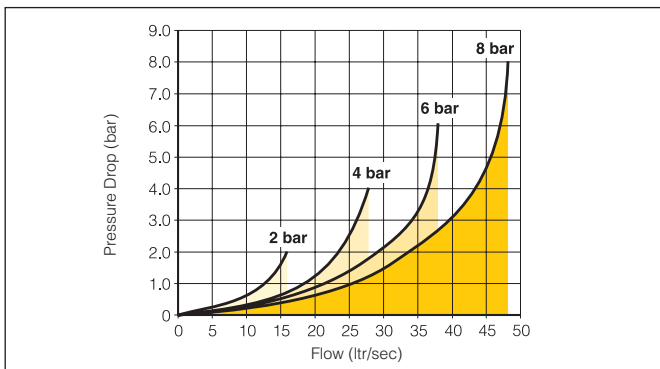

Port size	G1/4
Max operating pressure.	16 bar
Working temperature.	
Air pilot lever solenoid.	-40°C to + 60°C
Air pilot solenoid.	-10°C to + 50°C
Standard and food version.	-40°C to + 60°C
Mobile version.	-40°C to + 60°C
Flow (acc. to ISO 6358)	$c = 5,4 \text{ NI/s} \times \text{bar}$ $b = 0,2$ $Q_n = 21,5 \text{ l/s}$ $Q_{max} = 38,0 \text{ l/s}$ $C_v = 1,33$

**Technical Data P2LCX**

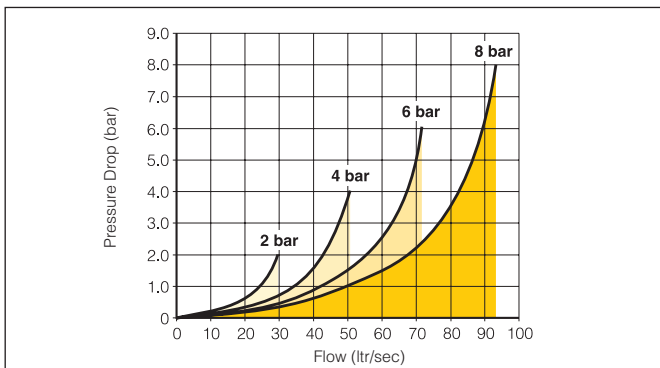

Port size	G3/8
Max operating pressure.	12 bar
Working temperature.	
Air pilot lever solenoid.	-40°C to + 60°C
Air pilot solenoid.	-10°C to + 50°C
Standard and food version.	-40°C to + 60°C
Mobile version.	-40°C to + 60°C
Flow (acc. to ISO 6358)	$c = 10,3 \text{ NI/s} \times \text{bar}$ $b = 0,22$ $Q_n = 41,0 \text{ l/s}$ $Q_{max} = 72,0 \text{ l/s}$ $C_v = 2,5$

**Technical Data P2LDX**

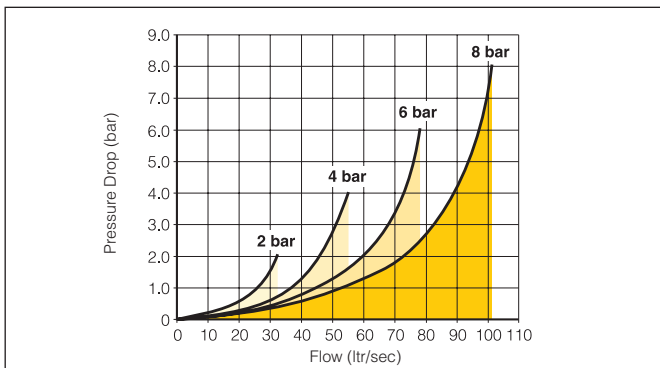

Port size	G1/2
Max operating pressure.	12 bar
Working temperature.	
Air pilot lever solenoid.	-40°C to + 60°C
Air pilot solenoid.	-10°C to + 50°C
Standard and food version.	-40°C to + 60°C
Mobile version.	-40°C to + 60°C
Flow (acc. to ISO 6358)	$c = 11,3 \text{ NI/s} \times \text{bar}$ $b = 0,3$ $Q_n = 44,3 \text{ l/s}$ $Q_{max} = 78 \text{ l/s}$ $C_v = 2,71$









Order chart - Viking Xtreme air pilot & manual valves - Xtreme operating pressure / temperature

<table border="1" style="width: 100%; border-collapse: collapse;"> <tr> <td style="width: 33%; text-align: center;"><b>P</b></td> <td style="width: 33%; text-align: center;"><b>2</b></td> <td style="width: 33%; text-align: center;"><b>L</b></td> </tr> <tr> <td colspan="3" style="text-align: center;"><b>Valve family</b></td> </tr> <tr> <td colspan="3">P2L Viking inline valve</td> </tr> </table>	<b>P</b>	<b>2</b>	<b>L</b>	<b>Valve family</b>			P2L Viking inline valve			<table border="1" style="width: 100%; border-collapse: collapse;"> <tr> <td style="width: 33%; text-align: center;"><b>A</b></td> <td style="width: 33%; text-align: center;"><b>X</b></td> <td style="width: 33%; text-align: center;"><b>5</b></td> </tr> <tr> <td colspan="3" style="text-align: center;"><b>Size</b></td> </tr> <tr> <td>A</td> <td>1/8</td> <td></td> </tr> <tr> <td>B</td> <td>1/4</td> <td></td> </tr> <tr> <td>C</td> <td>3/8</td> <td></td> </tr> <tr> <td>D</td> <td>1/2</td> <td></td> </tr> </table>	<b>A</b>	<b>X</b>	<b>5</b>	<b>Size</b>			A	1/8		B	1/4		C	3/8		D	1/2		<table border="1" style="width: 100%; border-collapse: collapse;"> <tr> <td style="width: 33%; text-align: center;"><b>1</b></td> <td style="width: 33%; text-align: center;"><b>1</b></td> <td style="width: 33%;"></td> </tr> <tr> <td colspan="3" style="text-align: center;"><b>Port thread</b></td> </tr> <tr> <td>11</td> <td>G1/8</td> <td></td> </tr> <tr> <td>12</td> <td>G1/4</td> <td></td> </tr> <tr> <td>13</td> <td>G3/8</td> <td></td> </tr> <tr> <td>14</td> <td>G1/2</td> <td></td> </tr> <tr> <td>91</td> <td>1/8 NPT</td> <td></td> </tr> <tr> <td>92</td> <td>1/4 NPT</td> <td></td> </tr> <tr> <td>93</td> <td>3/8 NPT</td> <td></td> </tr> <tr> <td>94</td> <td>1/2 NPT</td> <td></td> </tr> <tr> <td>1N *</td> <td>Namur G1/4</td> <td></td> </tr> <tr> <td>9N *</td> <td>Namur 1/4 NPT</td> <td></td> </tr> </table> <p style="font-size: small;">* Not available in 3/2 version</p>	<b>1</b>	<b>1</b>		<b>Port thread</b>			11	G1/8		12	G1/4		13	G3/8		14	G1/2		91	1/8 NPT		92	1/4 NPT		93	3/8 NPT		94	1/2 NPT		1N *	Namur G1/4		9N *	Namur 1/4 NPT		<table border="1" style="width: 100%; border-collapse: collapse;"> <tr> <td style="width: 33%; text-align: center;"><b>P</b></td> <td style="width: 33%; text-align: center;"><b>S</b></td> <td style="width: 33%;"></td> </tr> <tr> <td colspan="3" style="text-align: center;"><b>Pilot main actuator/return</b></td> </tr> <tr> <td>J ***</td> <td>Rotary button - 2 positions</td> <td></td> </tr> <tr> <td>P</td> <td>Air signal</td> <td></td> </tr> <tr> <td>S</td> <td>Spring (return only)</td> <td></td> </tr> <tr> <td>V</td> <td>Lever, 2 positions, 90° to ports</td> <td></td> </tr> <tr> <td>Z ***</td> <td>Lever, 2 positions, in line with ports</td> <td></td> </tr> <tr> <td>1 **</td> <td>Lever, 3 positions self centred, 90° to ports</td> <td></td> </tr> <tr> <td>2 **</td> <td>Lever, held 3 positions, 90° to ports</td> <td></td> </tr> <tr> <td>5 ***</td> <td>Lever, 3 positions, self centered in line with port</td> <td></td> </tr> <tr> <td>6 ***</td> <td>Lever, 3 positions, held in position in line with port</td> <td></td> </tr> <tr> <td>7 ***</td> <td>Rotary button - 3 positions held in position</td> <td></td> </tr> </table> <p style="font-size: small;">** Not available in 3/2 version *** Only Available with port threads G1/4 and 1/4 NPT</p>	<b>P</b>	<b>S</b>		<b>Pilot main actuator/return</b>			J ***	Rotary button - 2 positions		P	Air signal		S	Spring (return only)		V	Lever, 2 positions, 90° to ports		Z ***	Lever, 2 positions, in line with ports		1 **	Lever, 3 positions self centred, 90° to ports		2 **	Lever, held 3 positions, 90° to ports		5 ***	Lever, 3 positions, self centered in line with port		6 ***	Lever, 3 positions, held in position in line with port		7 ***	Rotary button - 3 positions held in position	
<b>P</b>	<b>2</b>	<b>L</b>																																																																																																				
<b>Valve family</b>																																																																																																						
P2L Viking inline valve																																																																																																						
<b>A</b>	<b>X</b>	<b>5</b>																																																																																																				
<b>Size</b>																																																																																																						
A	1/8																																																																																																					
B	1/4																																																																																																					
C	3/8																																																																																																					
D	1/2																																																																																																					
<b>1</b>	<b>1</b>																																																																																																					
<b>Port thread</b>																																																																																																						
11	G1/8																																																																																																					
12	G1/4																																																																																																					
13	G3/8																																																																																																					
14	G1/2																																																																																																					
91	1/8 NPT																																																																																																					
92	1/4 NPT																																																																																																					
93	3/8 NPT																																																																																																					
94	1/2 NPT																																																																																																					
1N *	Namur G1/4																																																																																																					
9N *	Namur 1/4 NPT																																																																																																					
<b>P</b>	<b>S</b>																																																																																																					
<b>Pilot main actuator/return</b>																																																																																																						
J ***	Rotary button - 2 positions																																																																																																					
P	Air signal																																																																																																					
S	Spring (return only)																																																																																																					
V	Lever, 2 positions, 90° to ports																																																																																																					
Z ***	Lever, 2 positions, in line with ports																																																																																																					
1 **	Lever, 3 positions self centred, 90° to ports																																																																																																					
2 **	Lever, held 3 positions, 90° to ports																																																																																																					
5 ***	Lever, 3 positions, self centered in line with port																																																																																																					
6 ***	Lever, 3 positions, held in position in line with port																																																																																																					
7 ***	Rotary button - 3 positions held in position																																																																																																					
<table border="1" style="width: 100%; border-collapse: collapse;"> <tr> <td colspan="3" style="text-align: center;"><b>Version</b></td> </tr> <tr> <td colspan="3">X Xtreme duty spool</td> </tr> </table> <p style="font-size: x-small;">* Xtreme duty spool suitable for max operating pressure 16 bar. (P2LAX + P2LBX) 12 bar (P2LCX + P2LDX) Temperature range -40°C to +60°C</p>		<b>Version</b>			X Xtreme duty spool			<table border="1" style="width: 100%; border-collapse: collapse;"> <tr> <td colspan="3" style="text-align: center;"><b>Valve type function</b></td> </tr> <tr> <td colspan="3" style="text-align: center;"><b>Manual and pneumatic operated</b></td> </tr> <tr> <td style="text-align: center;"><b>3</b></td> <td></td> <td>3/2 valve</td> </tr> <tr> <td style="text-align: center;"><b>5</b></td> <td></td> <td>5/2 valve</td> </tr> <tr> <td style="text-align: center;"><b>6</b></td> <td></td> <td>5/3 valve closed centre position</td> </tr> <tr> <td style="text-align: center;"><b>7</b></td> <td></td> <td>5/3 valve pressurised centre</td> </tr> <tr> <td style="text-align: center;"><b>8</b></td> <td></td> <td>5/3 valve vented centre</td> </tr> </table>			<b>Valve type function</b>			<b>Manual and pneumatic operated</b>			<b>3</b>		3/2 valve	<b>5</b>		5/2 valve	<b>6</b>		5/3 valve closed centre position	<b>7</b>		5/3 valve pressurised centre	<b>8</b>		5/3 valve vented centre																																																																							
<b>Version</b>																																																																																																						
X Xtreme duty spool																																																																																																						
<b>Valve type function</b>																																																																																																						
<b>Manual and pneumatic operated</b>																																																																																																						
<b>3</b>		3/2 valve																																																																																																				
<b>5</b>		5/2 valve																																																																																																				
<b>6</b>		5/3 valve closed centre position																																																																																																				
<b>7</b>		5/3 valve pressurised centre																																																																																																				
<b>8</b>		5/3 valve vented centre																																																																																																				
<table border="1" style="width: 100%; border-collapse: collapse;"> <tr> <td style="padding: 5px;">Shaded part numbers are standard</td> </tr> </table>		Shaded part numbers are standard																																																																																																				
Shaded part numbers are standard																																																																																																						

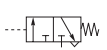
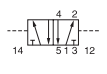
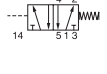
## Pneumatic pilot operated valves - Xtreme operating pressure / temperature

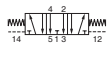
Max operating pressure 16 bar (A &amp; B) 12 bar (C &amp; D). temp range -40°C to +60°C





Symbol	Size	Actuation	Return	Min Operating Pressure (bar)	Changeover time (ms) at 6 bar @20°C actua./return	Weight Kg	Order code
<b>3/2 valves, temperature -40°C to +60°C</b>							
	G1/8	Air signal	Air signal	1,5	5/5	0,30	<b>P2LAX311PP</b>
	G1/4			1,5	5/5	0,30	<b>P2L BX312PP</b>
	G3/8			1,5	8/8	0,45	<b>P2LCX313PP</b>
	G1/2			1,5	9/9	0,45	<b>P2LDX314PP</b>
	G1/8	Air signal	Spring	3,2	8/15	0,30	<b>P2LAX311PS</b>
	G1/4			3,5	10/20	0,30	<b>P2L BX312PS</b>
	G3/8			3,5	10/30	0,45	<b>P2LCX313PS</b>
	G1/2			3,5	10/30	0,45	<b>P2LDX314PS</b>
<b>5/2 valves, temperature -40°C to +60°C</b>							
	G1/8	Air signal	Air signal	1,5	5/5	0,14	<b>P2LAX511PP</b>
	G1/4			1,5	6/6	0,30	<b>P2L BX512PP</b>
	G3/8			1,5	8/8	0,45	<b>P2LCX513PP</b>
	G1/2			1,5	9/9	0,45	<b>P2LDX514PP</b>
	G1/8	Air signal	Spring	3,2	8/15	0,15	<b>P2LAX511PS</b>
	G1/4			3,5	10/20	0,32	<b>P2L BX512PS</b>
	G3/8			3,5	10/30	0,45	<b>P2LCX513PS</b>
	G1/2			3,5	10/30	0,45	<b>P2LDX514PS</b>
<b>5/3 valves, temperature -40°C to +60°C</b>							
	G1/8	Air signal	Air signal	3,5	10/20	0,15	<b>P2LAX611PP</b>
	G1/4	Closed centre	Self	3,5	12/22	0,33	<b>P2L BX612PP</b>
	G3/8	position	centring	3,5	15/35	0,50	<b>P2LCX613PP</b>
	G1/2			3,5	15/35	0,50	<b>P2LDX614PP</b>
	G1/8	Air signal	Air signal	3,5	10/20	0,15	<b>P2LAX811PP</b>
	G1/4	Vented centre	Self	3,5	12/22	0,33	<b>P2L BX812PP</b>
	G3/8	position	centring	3,5	15/35	0,50	<b>P2LCX813PP</b>
	G1/2			3,5	15/35	0,50	<b>P2LDX814PP</b>
	G1/8	Air signal	Air signal	3,5	10/20	0,15	<b>P2LAX711PP</b>
	G1/4	Pressurised	Self	3,5	12/22	0,33	<b>P2L BX712PP</b>
	G3/8	centre	centring	3,5	15/35	0,50	<b>P2LCX713PP</b>
	G1/2	position		3,5	15/35	0,50	<b>P2LDX714PP</b>



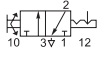
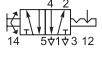

**Pneumatic twist operated valves - Xtreme operating pressure / temperature**

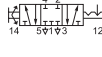
Max operating pressure 16 bar. Temp range -40°C to +60°C

Symbol	Size	Actuation	Return	Changeover Angle	Weight Kg	Order code
<b>3/2 valves, temperature -40°C to +60°C</b>						
	G1/4	Twist	Twist	45	0.34	<b>P2L BX312JJ</b>
<b>5/2 valves, temperature -40°C to +60°C</b>						
	G1/4	Twist	Twist	45	0.37	<b>P2L BX512JJ</b>
<b>5/3 valves, temperature -40°C to +60°C</b>						
	G1/4	Twist	Twist	54	0.41	<b>P2L BX71277</b>
	G1/4	Twist	Twist	54	0.41	<b>P2L BX61277</b>
	G1/4	Twist	Twist	54	0.41	<b>P2L BX81277</b>

## Lever operated directional control valves, lever 90° to ports

Max operating pressure 16 bar (A &amp; B) 12 bar (C &amp; D). temp range -40°C to +60°C

Symbol	Size	Actuation	Return	Changeover angle	Changeover Force	Type	Weight Kg	Order code
<b>3/2 valves, standard temperature / Low temperature, lever 90° to ports</b>								
	G1/8	Lever	Lever	20°	9 N	Std.	0,33	<b>P2LAX311VV</b>
	G1/4	Lever	Lever	20°	9 N	Std.	0,33	<b>P2LBX312VV</b>
	G3/8	Lever	Lever	32°	25 N	Std.	0,40	<b>P2LCX313VV</b>
	G1/2	Lever	Lever	32°	25 N	Std.	0,60	<b>P2LDX314VV</b>
	G1/8	Lever	Spring	20°	10N	Std.	0,33	<b>P2LAX311VS</b>
	G1/4	Lever	Spring	20°	10N	Std.	0,33	<b>P2LBX312VS</b>
	G3/8	Lever	Spring	32°	15 N	Std.	0,40	<b>P2LCX313VS</b>
	G1/2	Lever	Spring	32°	15 N	Std.	0,60	<b>P2LDX314VS</b>
<b>5/2 valves, standard temperature / Low temperature, lever 90° to ports</b>								
	G1/8	Lever	Lever	28°	9 N	Std.	0,18	<b>P2LAX511VV</b>
	G1/4	Lever	Lever	20°	9 N	Std.	0,33	<b>P2LBX512VV</b>
	G3/8	Lever	Lever	32°	25 N	Std.	0,40	<b>P2LCX513VV</b>
	G1/2	Lever	Lever	32°	25 N	Std.	0,60	<b>P2LDX514VV</b>
	G1/8	Lever	Spring	28°	10N	Std.	0,18	<b>P2LAX511VS</b>
	G1/4	Lever	Spring	20°	10N	Std.	0,33	<b>P2LBX512VS</b>
	G3/8	Lever	Spring	32°	15 N	Std.	0,40	<b>P2LCX513VS</b>
	G1/2	Lever	Spring	32°	15 N	Std.	0,60	<b>P2LDX514VS</b>
<b>5/3 valves, low temperature, lever 90° to ports</b>								
	G1/8	Lever	Lever	±14°	15 N	Std.	0,18	<b>P2LAX61122</b>
	G1/4	Closed centre position held in three positions		±12°	15 N	Std.	0,33	<b>P2LBX61222</b>
	G3/8			±16°	17 N	Std.	0,71	<b>P2LCX61322</b>
	G1/2			±16°	17 N	Std.	0,73	<b>P2LDX61422</b>
	G1/8	Lever	Lever	±14°	15 N	Std.	0,18	<b>P2LAX81122</b>
	G1/4	Exhausted centre position held in three positions		±12°	15 N	Std.	0,33	<b>P2LBX81222</b>
	G3/8			±16°	17 N	Std.	0,71	<b>P2LCX81322</b>
	G1/2			±16°	17 N	Std.	0,73	<b>P2LDX81422</b>
	G1/8	Lever	Lever	±14°	15 N	Std.	0,18	<b>P2LAX71122</b>
	G1/4	Pressure applied centre position held in three positions		±12°	15 N	Std.	0,33	<b>P2LBX71222</b>
	G3/8			±16°	17 N	Std.	0,71	<b>P2LCX71322</b>
	G1/2			±16°	17 N	Std.	0,73	<b>P2LDX71422</b>
	G1/8	Lever	Lever	±14°	16 N	Std.	0,18	<b>P2LAX61111</b>
	G1/4	Closed centre position Self centring		±12°	16 N	Std.	0,33	<b>P2LBX61211</b>
	G3/8			±16°	30 N	Std.	0,71	<b>P2LCX61311</b>
	G1/2			±16°	30 N	Std.	0,73	<b>P2LDX61411</b>
	G1/8	Lever	Lever	±14°	16 N	Std.	0,18	<b>P2LAX81111</b>
	G1/4	Exhausted centre position Self centring		±12°	16 N	Std.	0,33	<b>P2LBX81211</b>
	G3/8			±16°	30 N	Std.	0,71	<b>P2LCX81311</b>
	G1/2			±16°	30 N	Std.	0,73	<b>P2LDX81411</b>
	G1/8	Lever	Lever	±14°	16 N	Std.	0,18	<b>P2LAX71111</b>
	G1/4	Pressure applied centre position Self centring		±12°	16 N	Std.	0,33	<b>P2LBX71211</b>
	G3/8			±16°	30 N	Std.	0,71	<b>P2LCX71311</b>
	G1/2			±16°	30 N	Std.	0,73	<b>P2LDX71411</b>



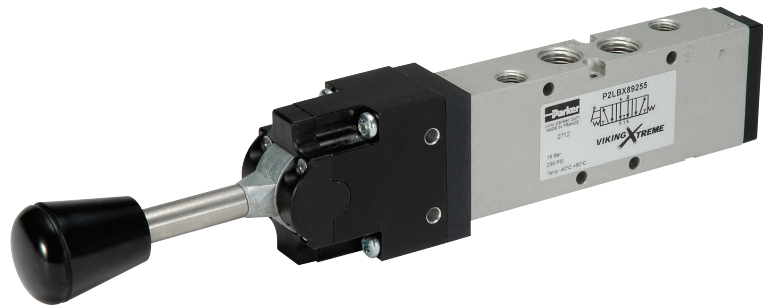

### Lever operated directional control valves, lever in line with ports

Max operating pressure 16 bar. Temp range -40°C to +60°C

Symbol	Size	Actuation	Return	Changeover angle	Changeover Force	Type	Weight Kg	Order code
<b>3/2 valves, temperature -40°C to +60°C, Lever In Line with ports</b>								
	G1/4	Lever	Lever	26°	18 N	Std.	0,42	<b>P2LXB312ZZ</b>
	G1/4	Lever	Spring	26°	18 N	Std.	0,42	<b>P2LXB312ZS</b>
<b>5/2 valves, temperature -40°C to +60°C, Lever In Line with ports</b>								
	G1/4	Lever	Lever	26°	18 N	Std.	0,45	<b>P2LXB512ZZ</b>
	G1/4	Lever	Spring	26°	18 N	Std.	0,45	<b>P2LXB512ZS</b>
<b>5/3 valves, temperature -40°C to +60°C, Lever In Line with ports</b>								
	G1/4	Lever	Lever	15° / 15°	24 N	Std.	0,51	<b>P2LXB61255</b>
	G1/4	Lever	Lever	15° / 15°	24 N	Std.	0,51	<b>P2LXB71255</b>
	G1/4	Lever	Lever	15° / 15°	24 N	Std.	0,51	<b>P2LXB81255</b>
	G1/4	Lever	Lever	15° / 15°	18 N	Std.	0,48	<b>P2LXB61266</b>
	G1/4	Lever	Lever	15° / 15°	18 N	Std.	0,48	<b>P2LXB71266</b>
	G1/4	Lever	Lever	15° / 15°	18 N	Std.	0,48	<b>P2LXB81266</b>

Order chart - Viking Xtreme Normal Operating Pressure / Temperature

<b>P</b>	<b>2</b>	<b>L</b>	<b>A</b>	<b>X</b>	<b>5</b>	<b>1</b>	<b>1</b>	<b>E</b>	<b>S</b>	<b>N</b>	<b>D</b>	<b>D</b>	<b>B</b>	<b>4</b>	<b>9</b>
----------	----------	----------	----------	----------	----------	----------	----------	----------	----------	----------	----------	----------	----------	----------	----------

Valve family	
<b>P2L</b>	Viking inline valve

Size	
<b>A</b>	1/8
<b>B</b>	1/4
<b>C</b>	3/8
<b>D</b>	1/2

Version	
<b>X</b>	Xtreme duty spool

Port thread	
<b>11</b>	G1/8
<b>12</b>	G1/4
<b>13</b>	G3/8
<b>14</b>	G1/2
<b>91</b>	1/8 NPT
<b>92</b>	1/4 NPT
<b>93</b>	3/8 NPT
<b>94</b>	1/2 NPT
<b>1N *</b>	Namur G1/4
<b>9N *</b>	Namur 1/4 NPT

\* Namur version not available in 3/2 function

Solenoid pilot type	
<b>N</b>	10 bar / -10°C to 50°C
<b>L**</b>	10 bar / -10°C to 50°C

Solenoid exhaust	
<b>D</b>	Vented
<b>N</b>	Captured/tapped M5
<b>X</b>	15mm solenoid vented

Valve type function	
<b>Solenoid operated with internal supply to solenoid</b>	
<b>3</b>	3/2 valve
<b>5</b>	5/2 valve
<b>6</b>	5/3 valve closed centre position
<b>7</b>	5/3 valve pressurised centre
<b>8</b>	5/3 valve vented centre
<b>Solenoid operated with external pilot supply to solenoids through ports 10 &amp; 12 for 3/2 version and through ports 12 &amp; 14 for 5/2 &amp; 5/3 version</b>	
<b>L</b>	3/2 valve
<b>N</b>	5/2 valve
<b>P</b>	5/3 valve closed centre position
<b>Q</b>	5/3 valve pressurised centre
<b>R</b>	5/3 valve vented centre

Overrides	
<b>A*</b>	None
<b>B*</b>	Flush - non locking
<b>C</b>	Flush - locking
<b>D<sup>1</sup></b>	Extended non-locking
<b>E*</b>	Extended - locking
<b>X</b>	Less 15mm solenoid

\* Only available with enclosure 5  
<sup>1</sup> 22mm solenoid option

Voltage <sup>2</sup>			
	AC		DC
	60Hz	50Hz	
<b>40</b>	12		
<b>42</b>	24	22	
<b>45</b>			12
<b>47*</b>			12
<b>48*</b>			24
<b>49</b>			24
<b>53</b>	120	110	
<b>57</b>	240	230	
<b>XX</b>	valve less solenoid/coil		

\* If 22mm solenoid required on mobile applications use model code no page 16. Alternatively check operating temperature and pressures with our technical department.

Pilot main actuator / Return	
<b>E</b>	Solenoid operated valve
<b>S</b>	Spring (return only)
<b>P</b>	Press (return only)

Solenoid enclosure / Lead length	
<b>5</b>	15mm, 3 pin Form C/ISO15217 in line with body
<b>B</b>	22mm 3-pin Industrial Form B with coil
<b>N</b>	22mm solenoid pilot less coil
<b>X</b>	Valve less 15mm solenoid
<b>L**</b>	Low power 22mm solenoid (only available with 24V DC)

Shaded part numbers are standard







  

<sup>2</sup> Shaded part numbers are available from stock  
Unshaded part numbers are available on request but will be subject to minimum order quantities  
Otherwise order coil/solenoid and valve separately.

### Solenoid operated directional control valves fitted with 15mm solenoid(s) 24V DC

Solenoid plug/connector to ordered separately.

Internal supply to solenoid valve(s) via port 1. Max operating pressure 10 bar, temp range -10°C to +50°C

Symbol	Size	Actuation	Return	Min Operating Pressure (bar)	Changeover time (ms) at 6 bar @20°C actua./return	Weight Kg	Order code
<b>3/2 valves, internal air, standard temperature</b>							
	G1/8	Electric signal	Electric signal	1,5	10/10	0,42	<b>P2LAX311EENXB549</b>
	G1/4			1,5	10/12	0,42	<b>P2LBX312EENXB549</b>
	G3/8			1,5	17/17	0,53	<b>P2LCX313EENXB549</b>
	G1/2			1,5	17/17	0,53	<b>P2LDX314EENXB549</b>
	G1/8	Electric signal	Spring	3,2	18/40	0,38	<b>P2LAX311ESNXB549</b>
	G1/4			3,5	18/45	0,38	<b>P2LBX312ESNXB549</b>
	G3/8			3,5	25/75	0,50	<b>P2LCX313ESNXB549</b>
	G1/2			3,5	25/75	0,50	<b>P2LDX314ESNXB549</b>
<b>5/2 valves, internal air, standard temperature</b>							
	G1/8	Electric signal	Electric signal	1,5	10/10	0,27	<b>P2LAX511EENXB549</b>
	G1/4			1,5	12/12	0,42	<b>P2LBX512EENXB549</b>
	G3/8			1,5	17/17	0,53	<b>P2LCX513EENXB549</b>
	G1/2			1,5	17/17	0,53	<b>P2LDX514EENXB549</b>
	G1/8	Electric signal	Spring	3,2	15/35	0,22	<b>P2LAX511ESNXB549</b>
	G1/4			3,5	18/45	0,38	<b>P2LBX512ESNXB549</b>
	G3/8			3,5	25/75	0,50	<b>P2LCX513ESNXB549</b>
	G1/2			3,5	25/75	0,50	<b>P2LDX514ESNXB549</b>
<b>5/3 valves, internal air, standard temperature</b>							
	G1/8	Electric signal	Electric signal	3,5	18/40	0,28	<b>P2LAX611EENXB549</b>
	G1/4	Closed centre	Self	3,5	22/55	0,44	<b>P2LBX612EENXB549</b>
	G3/8	position	centring	3,5	30/90	0,55	<b>P2LCX613EENXB549</b>
	G1/2			3,5	30/95	0,55	<b>P2LDX614EENXB549</b>
	G1/8	Electric signal	Electric signal	3,5	18/40	0,28	<b>P2LAX811EENXB549</b>
	G1/4	Vented centre	Self	3,5	22/55	0,44	<b>P2LBX812EENXB549</b>
	G3/8	position	centring	3,5	30/90	0,55	<b>P2LCX813EENXB549</b>
	G1/2			3,5	30/95	0,55	<b>P2LDX814EENXB549</b>
	G1/8	Electric signal	Electric signal	3,5	18/40	0,28	<b>P2LAX711EENXB549</b>
	G1/4	Pressurised	Self	3,5	22/55	0,44	<b>P2LBX712EENXB549</b>
	G3/8	centre	centring	3,5	30/90	0,55	<b>P2LCX713EENXB549</b>
	G1/2	position		3,5	30/95	0,55	<b>P2LDX714EENXB549</b>



### Solenoid operated directional control valves fitted with adapter to accept 15mm solenoid(s)

Solenoid operator(s) and connector/plug(s) should be ordered separately.

Internal supply to solenoid valve(s) via port 1. Max operating pressure 10 bar, temp range -10°C to +50°C

Symbol	Size	Actuation	Return	Min Operating Pressure (bar)	Changeover time (ms) at 6 bar @20°C actua./return	Weight Kg	Order code
<b>3/2 valves, internal air, standard temperature</b>							
	G1/8	Electric signal	Electric signal	1,5	10/10	0,38	P2LAX311EENXXX
	G1/4			1,5	10/12	0,38	P2LBX312EENXXX
	G3/8			1,5	17/17	0,45	P2LCX313EENXXX
	G1/2			1,5	17/17	0,45	P2LDX314EENXXX
	G1/8	Electric signal	Spring	3,2	18/40	0,38	P2LAX311ESNXXX
	G1/4			3,5	18/45	0,38	P2LBX312ESNXXX
	G3/8			3,5	25/75	0,42	P2LCX313ESNXXX
	G1/2			3,5	25/75	0,42	P2LDX314ESNXXX
<b>5/2 valves, internal air, standard temperature</b>							
	G1/8	Electric signal	Electric signal	1,5	10/10	0,27	P2LAX511EENXXX
	G1/4			1,5	12/12	0,42	P2LBX512EENXXX
	G3/8			1,5	17/17	0,45	P2LCX513EENXXX
	G1/2			1,5	17/17	0,45	P2LDX514EENXXX
	G1/8	Electric signal	Spring	3,2	15/35	0,22	P2LAX511ESNXXX
	G1/4			3,5	18/45	0,38	P2LBX512ESNXXX
	G3/8			3,5	25/75	0,42	P2LCX513ESNXXX
	G1/2			3,5	25/75	0,42	P2LDX514ESNXXX
<b>5/3 valves, internal air, standard temperature</b>							
	G1/8	Electric signal	Electric signal	3,5	18/40	0,28	P2LAX611EENXXX
	G1/4	Closed centre	Self	3,5	22/55	0,44	P2LBX612EENXXX
	G3/8	position	centring	3,5	30/90	0,55	P2LCX613EENXXX
	G1/2			3,5	30/95	0,55	P2LDX614EENXXX
	G1/8	Electric signal	Electric signal	3,5	18/40	0,28	P2LAX811EENXXX
	G1/4	Vented centre	Self	3,5	22/55	0,44	P2LBX812EENXXX
	G3/8	position	centring	3,5	30/90	0,55	P2LCX813EENXXX
	G1/2			3,5	30/95	0,55	P2LDX814EENXXX
	G1/8	Electric signal	Electric signal	3,5	18/40	0,28	P2LAX711EENXXX
	G1/4	Pressurised	Self	3,5	22/55	0,44	P2LBX712EENXXX
	G3/8	centre	centring	3,5	30/90	0,55	P2LCX713EENXXX
	G1/2	position		3,5	30/95	0,55	P2LDX714EENXXX

### Solenoid operated directional control valves fitted with adapter to accept 15mm solenoid(s)

Solenoid operator(s) and connector/plug(s) should be ordered separately.

External supply to solenoid valve(s) via ports 10 & 12 for 3/2 version and via port 12 & 14 for 5/2 and 5/3 version.







Max operating pressure 10 bar, temp range -10°C to +50°C

Symbol	Size	Actuation	Return	Min Operating Pressure (bar)	Changeover time (ms) at 6 bar @20°C actua./return	Weight Kg	Order code
<b>3/2 valves, external air, standard temperature</b>							
	G1/8	Electric signal	Electric signal	1,5	10/10	0,34	<b>P2LAXL11EENXXX</b>
	G1/4			1,5	10/12	0,34	<b>P2LBXL12EENXXX</b>
	G3/8			1,5	17/17	0,45	<b>P2LCXL13EENXXX</b>
	G1/2			1,5	17/17	0,45	<b>P2LDXL14EENXXX</b>
	G1/8	Electric signal	Spring	3,2	18/40	0,34	<b>P2LAXL11ESNXXX</b>
	G1/4			3,5	18/45	0,34	<b>P2LBXL12ESNXXX</b>
	G3/8			3,5	25/75	0,42	<b>P2LCXL13ESNXXX</b>
	G1/2			3,5	25/75	0,42	<b>P2LDXL14ESNXXX</b>
<b>5/2 valves, external air, standard temperature</b>							
	G1/8	Electric signal	Electric signal	1,5	10/10	0,19	<b>P2LAXN11EENXXX</b>
	G1/4			1,5	12/12	0,34	<b>P2LBXN12EENXXX</b>
	G3/8			1,5	17/17	0,45	<b>P2LCXN13EENXXX</b>
	G1/2			1,5	17/17	0,45	<b>P2LDXN14EENXXX</b>
	G1/8	Electric signal	Spring	3,2	15/35	0,18	<b>P2LAXN11ESNXXX</b>
	G1/4			3,5	18/45	0,34	<b>P2LBXN12ESNXXX</b>
	G3/8			3,5	25/75	0,42	<b>P2LCXN13ESNXXX</b>
	G1/2			3,5	25/75	0,42	<b>P2LDXN14ESNXXX</b>
<b>5/3 valves, external air, standard temperature</b>							
	G1/8	Electric signal	Electric signal	3,5	18/40	0,20	<b>P2LAXP11EENXXX</b>
	G1/4	Closed centre	Self	3,5	22/55	0,36	<b>P2LBXP12EENXXX</b>
	G3/8	position	centring	3,5	30/90	0,55	<b>P2LCXP13EENXXX</b>
	G1/2			3,5	30/95	0,55	<b>P2LDXP14EENXXX</b>
	G1/8	Electric signal	Electric signal	3,5	18/40	0,20	<b>P2LAXR11EENXXX</b>
	G1/4	Vented centre	Self	3,5	22/55	0,36	<b>P2LBXR12EENXXX</b>
	G3/8	position	centring	3,5	30/90	0,55	<b>P2LCXR13EENXXX</b>
	G1/2			3,5	30/95	0,55	<b>P2LDXR14EENXXX</b>
	G1/8	Electric signal	Electric signal	3,5	18/40	0,20	<b>P2LAXQ11EENXXX</b>
	G1/4	Pressurised	Self	3,5	22/55	0,36	<b>P2LBXQ12EENXXX</b>
	G3/8	centre	centring	3,5	30/90	0,55	<b>P2LCXQ13EENXXX</b>
	G1/2	position		3,5	30/95	0,55	<b>P2LDXQ14EENXXX</b>

### Solenoid operated directional control valves fitted with 22mm solenoid(s) 24V DC

Solenoid plug/connector to be ordered separately.

Internal supply to solenoid valve(s) via port 1. Max operating pressure 10 bar, Temperature range -10°C to +50°C

Symbol	Size	Actuation	Return	Min Operating Pressure (bar)	Changeover time (ms) at 6 bar @20°C actua./return	Weight Kg	Order code
<b>3/2 valves, internal air, standard temperature</b>							
	G1/8	Electric signal	Electric signal	1,5	10/10	0,42	<b>P2LAX311EENDDB49</b>
	G1/4			1,5	10/12	0,42	<b>P2LBX312EENDDB49</b>
	G3/8			1,5	17/17	0,81	<b>P2LCX313EENDDB49</b>
	G1/2			1,5	17/17	0,81	<b>P2LDX314EENDDB49</b>
	G1/8	Electric signal	Spring	3,2	18/40	0,38	<b>P2LAX311ESNDDB49</b>
	G1/4			3,5	18/45	0,38	<b>P2LBX312ESNDDB49</b>
	G3/8			3,5	25/75	0,76	<b>P2LCX313ESNDDB49</b>
	G1/2			3,5	25/75	0,76	<b>P2LDX314ESNDDB49</b>
<b>5/2 valves, internal air, standard temperature</b>							
	G1/8	Electric signal	Electric signal	1,5	10/10	0,27	<b>P2LAX511EENDDB49</b>
	G1/4			1,5	12/12	0,42	<b>P2LBX512EENDDB49</b>
	G3/8			1,5	17/17	0,81	<b>P2LCX513EENDDB49</b>
	G1/2			1,5	17/17	0,81	<b>P2LDX514EENDDB49</b>
	G1/8	Electric signal	Spring	3,2	15/35	0,22	<b>P2LAX511ESNDDB49</b>
	G1/4			3,5	18/45	0,38	<b>P2LBX512ESNDDB49</b>
	G3/8			3,5	27/75	0,76	<b>P2LCX513ESNDDB49</b>
	G1/2			3,5	25/75	0,76	<b>P2LDX514ESNDDB49</b>
<b>5/3 valves, internal air, standard temperature</b>							
	G1/8	Electric signal	Electric signal	3,5	18/40	0,28	<b>P2LAX611EENDDB49</b>
	G1/4	Closed centre	Self	3,5	22/55	0,44	<b>P2LBX612EENDDB49</b>
	G3/8	position	centring	3,5	30/90	1,11	<b>P2LCX613EENDDB49</b>
	G1/2			3,5	30/90	1,11	<b>P2LDX614EENDDB49</b>
	G1/8	Electric signal	Electric signal	3,5	18/40	0,28	<b>P2LAX811EENDDB49</b>
	G1/4	Vented centre	Self	3,5	22/45	0,44	<b>P2LBX812EENDDB49</b>
	G3/8	position	centring	3,5	30/90	1,11	<b>P2LCX813EENDDB49</b>
	G1/2			3,5	30/90	1,11	<b>P2LDX814EENDDB49</b>
	G1/8	Electric signal	Electric signal	3,5	18/40	0,28	<b>P2LAX711EENDDB49</b>
	G1/4	Pressurised	Self	3,5	22/45	0,44	<b>P2LBX712EENDDB49</b>
	G3/8	centre	centring	3,5	30/90	1,11	<b>P2LCX713EENDDB49</b>
	G1/2	position		3,5	30/90	1,11	<b>P2LDX714EENDDB49</b>



### Solenoid operated directional control valves (supplied with 22mm solenoid operator less coil)

Solenoid plug/connector to be ordered separately.

Internal supply to solenoid valve(s) via port 1.

Symbol	Size	Actuation	Return	Min Operating Pressure (bar)	Changeover time (ms) at 6 bar @20°C actua./return	Weight Kg	Order code
<b>3/2 valves, internal air, standard temperature</b>							
	G1/8	Electric signal	Electric signal	1,5	10/10	0,31	<b>P2LAX311EENDDN</b>
	G1/4			1,5	10/12	0,31	<b>P2LBX312EENDDN</b>
	G3/8			1,5	17/17	0,41	<b>P2LCX313EENDDN</b>
	G1/2			1,5	17/17	0,41	<b>P2LDX314EENDDN</b>
	G1/8	Electric signal	Spring	3,2	18/40	0,31	<b>P2LAX311ESNDDN</b>
	G1/4			3,5	18/45	0,31	<b>P2LBX312ESNDDN</b>
	G3/8			3,5	25/75	0,40	<b>P2LCX313ESNDDN</b>
	G1/2			3,5	25/75	0,40	<b>P2LDX314ESNDDN</b>
<b>5/2 valves, internal air, standard temperature</b>							
	G1/8	Electric signal	Electric signal	1,5	9/9	0,16	<b>P2LAX511EENDDN</b>
	G1/4			1,5	10/10	0,31	<b>P2LBX512EENDDN</b>
	G3/8			1,5	13/13	0,41	<b>P2LCX513EENDDN</b>
	G1/2			1,5	13/13	0,41	<b>P2LDX514EENDDN</b>
	G1/8	Electric signal	Spring	3,2	12/38	0,16	<b>P2LAX511ESNDDN</b>
	G1/4			3,5	14/42	0,31	<b>P2LBX512ESNDDN</b>
	G3/8			3,5	16/60	0,40	<b>P2LCX513ESNDDN</b>
	G1/2			3,5	16/60	0,40	<b>P2LDX514ESNDDN</b>
<b>5/3 valves, internal air, standard temperature</b>							
	G1/8	Electric signal	Electric signal	3,5	15/40	0,17	<b>P2LAX611EENDDN</b>
	G1/4	Closed centre	Self	3,5	18/50	0,33	<b>P2LBX612EENDDN</b>
	G3/8	position	centring	3,5	20/65	1,00	<b>P2LCX613EENDDN</b>
	G1/2			3,5	20/70	1,00	<b>P2LDX614EENDDN</b>
	G1/8	Electric signal	Electric signal	3,5	15/40	0,17	<b>P2LAX811EENDDN</b>
	G1/4	Vented centre	Self	3,5	18/50	0,33	<b>P2LBX812EENDDN</b>
	G3/8	position	centring	3,5	20/65	1,00	<b>P2LCX813EENDDN</b>
	G1/2			3,5	20/70	1,00	<b>P2LDX814EENDDN</b>
	G1/8	Electric signal	Electric signal	3,5	15/40	0,17	<b>P2LAX711EENDDN</b>
	G1/4	Pressurised	Self	3,5	18/50	0,33	<b>P2LBX712EENDDN</b>
	G3/8	centre	centring	3,5	20/65	1,00	<b>P2LCX713EENDDN</b>
	G1/2	position		3,5	20/70	1,00	<b>P2LDX714EENDDN</b>

**Solenoid operated directional control valves (supplied with 22mm solenoid less coil)**

Solenoid plug/connector to be ordered separately.

External supply to solenoid valve(s) via ports 10 &amp; 12 for 3/2 version and via port 12 &amp; 14 for 5/2 and 5/3 version

Standard temp range -10°C to +50°C. Max operating pressure 10 bar

Symbol	Size	Actuation	Return	Min Operating Pressure (bar)	Changeover time (ms) at 6 bar @20°C actua./return	Weight Kg	Order code
<b>3/2 valves, external air, standard temperature</b>							
	G1/8	Electric signal	Electric signal	1,5	10/10	0,31	<b>P2LAXL11EENDDN</b>
	G1/4			1,5	10/12	0,31	<b>P2LBXL12EENDDN</b>
	G3/8			1,5	17/17	0,70	<b>P2LCXL13EENDDN</b>
	G1/2			1,5	17/17	0,70	<b>P2LDXL14EENDDN</b>
	G1/8	Electric signal	Spring	3,2	18/40	0,30	<b>P2LAXL11ESNDDN</b>
	G1/4			3,5	18/45	0,30	<b>P2LBXL12ESNDDN</b>
	G3/8			3,5	25/75	0,70	<b>P2LCXL13ESNDDN</b>
	G1/2			3,5	25/75	0,70	<b>P2LDXL14ESNDDN</b>
<b>5/2 valves, external air, standard temperature</b>							
	G1/8	Electric signal	Electric signal	1,5	9/9	0,16	<b>P2LAXN11EENDDN</b>
	G1/4			1,5	10/10	0,31	<b>P2LBXN12EENDDN</b>
	G3/8			1,5	13/13	0,70	<b>P2LCXN13EENDDN</b>
	G1/2			1,5	13/13	0,70	<b>P2LDXN14EENDDN</b>
	G1/8	Electric signal	Spring	3,2	12/38	0,16	<b>P2LAXN11ESNDDN</b>
	G1/4			3,5	14/42	0,30	<b>P2LBXN12ESNDDN</b>
	G3/8			3,5	16/60	0,70	<b>P2LCXN13ESNDDN</b>
	G1/2			3,5	16/60	0,70	<b>P2LDXN14ESNDDN</b>
<b>5/3 valves, external air, standard temperature</b>							
	G1/8	Electric signal	Electric signal	3,5	15/40	0,17	<b>P2LAXP11EENDDN</b>
	G1/4	Closed centre	Self	3,5	18/50	0,33	<b>P2LBXP12EENDDN</b>
	G3/8	position	centring	3,5	20/65	1,00	<b>P2LCXP13EENDDN</b>
	G1/2			3,5	20/70	1,00	<b>P2LDXP14EENDDN</b>
	G1/8	Electric signal	Electric signal	3,5	15/40	0,17	<b>P2LAXR11EENDDN</b>
	G1/4	Vented centre	Self	3,5	18/50	0,33	<b>P2LBXR12EENDDN</b>
	G3/8	position	centring	3,5	20/65	1,00	<b>P2LCXR13EENDDN</b>
	G1/2			3,5	20/70	1,00	<b>P2LDXR14EENDDN</b>
	G1/8	Electric signal	Electric signal	3,5	15/40	0,17	<b>P2LAXQ11EENDDN</b>
	G1/4	Pressurised	Self	3,5	18/50	0,33	<b>P2LBXQ12EENDDN</b>
	G3/8	centre	centring	3,5	20/65	1,00	<b>P2LCXQ13EENDDN</b>
	G1/2	position		3,5	20/70	1,00	<b>P2LDXQ14EENDDN</b>

Order chart - Viking Xtreme Valves - Xtreme operating pressure / temperature

**P 2 L A X 5 1 1 E S H D D B 4 9**

<b>Valve family</b>	
<b>P2L</b>	Viking inline valve

<b>Size</b>	
<b>A</b>	1/8
<b>B</b>	1/4
<b>C</b>	3/8
<b>D</b>	1/2

<b>Version</b>	
<b>X</b>	Xtreme duty spool











<b>Port thread</b>	
<b>11</b>	G1/8
<b>12</b>	G1/4
<b>13</b>	G3/8
<b>14</b>	G1/2
<b>91</b>	1/8 NPT
<b>92</b>	1/4 NPT
<b>93</b>	3/8 NPT
<b>94</b>	1/2 NPT

<b>Solenoid pilot type</b>	
<b>H<sup>1</sup></b>	16 bar / -40°C to 60°C

<sup>1</sup> Solenoid operated 'H' version supplied with B type enclosure 16 bar solenoid

<b>Solenoid exhaust</b>	
<b>D</b>	Vented
<b>N</b>	Capture/tapped M5

<b>Overrides</b>	
<b>D</b>	Extended non-locking

<b>Valve type function</b>		
<b>Solenoid operated with internal supply to solenoid</b>		
<b>3</b>		3/2 valve
<b>5</b>		5/2 valve
<b>6</b>		5/3 valve closed centre position
<b>7</b>		5/3 valve pressurised centre
<b>8</b>		5/3 valve vented centre
<b>Solenoid operated with external pilot supply to solenoids through ports 10 &amp; 12 for 3/2 version and through ports 12 &amp; 14 for 5/2 &amp; 5/3 version</b>		
<b>L</b>		3/2 valve
<b>N</b>		5/2 valve
<b>P</b>		5/3 valve closed centre position
<b>Q</b>		5/3 valve pressurised centre
<b>R</b>		5/3 valve vented centre

<b>Voltage<sup>3</sup></b>		
	<b>AC</b>	<b>DC</b>
	<b>60Hz</b>	<b>50Hz</b>
<b>40</b>	12	
<b>42</b>	24	22
<b>45</b>		12
<b>47*</b>		12
<b>48*</b>		24
<b>49</b>		24
<b>53</b>	120	110
<b>57</b>	240	230
<b>72</b>		110
<b>XX</b>	valve less solenoid/coil	

<sup>3</sup> Mobile voltage see page 51 operating parameters

<sup>3</sup> Shaded part numbers are available from stock  
Unshaded part numbers are available on request but will be subject to minimum order quantities  
Otherwise order coil and valve separately.

<b>Pilot main actuator / Return</b>	
<b>E</b>	Solenoid operated valve
<b>S</b>	Spring (return only)
<b>P</b>	Press (return only)

<b>Solenoid enclosure / Lead length</b>	
<b>A</b>	22mm Solenoid pilot & 30mm coil Form A
<b>B</b>	22mm Solenoid pilot & 22mm coil Industrial Form B
<b>N</b>	22mm Solenoid pilot less coil

Shaded part numbers are standard





### Solenoid operated directional control valves - Xtreme duty -40°C to +60°C P2LAX/P2LBX - 16 bar, P2LCX/P2LDX - 12 bar

Valves fitted with 22mm solenoid operator(s) less coil(s). Order coils and plug/connectors separately  
Internal supply to solenoid valve(s) via port 1. Connector/cable plugs to be ordered separately.

Symbol	Size	Actuation	Return	Min Operating Pressure (bar)	Changeover time (ms) at 6 bar @20°C actua./return	Weight Kg	Order code
<b>3/2 valves, internal air, low temperature</b>							
	G1/8	Electric signal	Electric signal	1,5	11/11	0,31	<b>P2LAX311EEHDDN</b>
	G1/4			1,5	13/13	0,31	<b>P2LBX312EEHDDN</b>
	G3/8			1,5	18/18	0,41	<b>P2LCX313EEHDDN</b>
	G1/2			1,5	18/18	0,41	<b>P2LDX314EEHDDN</b>
	G1/8	Electric signal	Spring	3,2	15/45	0,31	<b>P2LAX311ESHDDN</b>
	G1/4			3,5	25/65	0,31	<b>P2LBX312ESHDDN</b>
	G3/8			3,5	25/85	0,40	<b>P2LCX313ESHDDN</b>
	G1/2			3,5	25/85	0,40	<b>P2LDX314ESHDDN</b>
<b>5/2 valves, internal air, low temperature</b>							
	G1/8	Electric signal	Electric signal	1,5	11/11	0,16	<b>P2LAX511EEHDDN</b>
	G1/4			1,5	13/13	0,31	<b>P2LBX512EEHDDN</b>
	G3/8			1,5	18/18	0,41	<b>P2LCX513EEHDDN</b>
	G1/2			1,5	18/18	0,41	<b>P2LDX514EEHDDN</b>
	G1/8	Electric signal	Spring	3,2	15/45	0,16	<b>P2LAX511ESHDDN</b>
	G1/4			3,2	20/55	0,31	<b>P2LBX512ESHDDN</b>
	G3/8			3,2	25/85	0,40	<b>P2LCX513ESHDDN</b>
	G1/2			3,2	25/85	0,40	<b>P2LDX514ESHDDN</b>
<b>5/3 valves, internal air, low temperature</b>							
	G1/8	Electric signal	Electric signal	3,5	18/50	0,17	<b>P2LAX611EEHDDN</b>
	G1/4	Closed centre	Self	3,5	25/65	0,33	<b>P2LBX612EEHDDN</b>
	G3/8	position	centring	3,5	30/90	0,42	<b>P2LCX613EEHDDN</b>
	G1/2			3,5	30/95	0,42	<b>P2LDX614EEHDDN</b>
	G1/8	Electric signal	Electric signal	3,5	18/50	0,17	<b>P2LAX811EEHDDN</b>
	G1/4	Vented centre	Self	3,5	25/65	0,33	<b>P2LBX812EEHDDN</b>
	G3/8	position	centring	3,5	30/90	0,42	<b>P2LCX813EEHDDN</b>
	G1/2			3,5	30/95	0,42	<b>P2LDX814EEHDDN</b>
	G1/8	Electric signal	Electric signal	3,5	18/50	0,17	<b>P2LAX711EEHDDN</b>
	G1/4	Pressurised	Self	3,5	25/65	0,33	<b>P2LBX712EEHDDN</b>
	G3/8	centre	centring	3,5	30/90	0,42	<b>P2LCX713EEHDDN</b>
	G1/2	position		3,5	30/95	0,42	<b>P2LDX714EEHDDN</b>

## Solenoid operated directional control valves - Xtreme duty -40°C to + 60°C

## P2LAX/P2LBX - 16 bar, P2LCX/P2LDX - 12 bar

Valves fitted with 22mm solenoid operator(s) less coil(s). Order coils and plug/connectors separately

External supply to solenoid valve(s) via ports 10 &amp; 12 for 3/2 version and via port 12 &amp; 14 for 5/2 and 5/3 version

Symbol	Size	Actuation	Return	Min Operating Pressure (bar)	Changeover time (ms) at 6 bar @20°C actua./return	Weight Kg	Order code
<b>3/2 valves, external air standard temperature</b>							
	G1/8	Electric signal	Electric signal	1,5	10/10	0,42	<b>P2LAXL11EEHDDN</b>
	G1/4			1,5	10/12	0,42	<b>P2LBXL12EEHDDN</b>
	G3/8			1,5	17/17	0,81	<b>P2LCXL13EEHDDN</b>
	G1/2			1,5	17/17	0,81	<b>P2LDXL14EEHDDN</b>
	G1/8	Electric signal	Spring	3,2	18/40	0,42	<b>P2LAXL11ESHDDN</b>
	G1/4			3,5	18/45	0,42	<b>P2LBXL12ESHDDN</b>
	G3/8			3,5	25/75	0,76	<b>P2LCXL13ESHDDN</b>
	G1/2			3,5	25/75	0,76	<b>P2LDXL14ESHDDN</b>
<b>5/2 valves, external air to pilot operators</b>							
	G1/8	Electric signal	Electric signal	1,5	11/11	0,27	<b>P2LAXN11EEHDDN</b>
	G1/4			1,5	13/13	0,42	<b>P2LBXN12EEHDDN</b>
	G3/8			1,5	18/18	0,81	<b>P2LCXN13EEHDDN</b>
	G1/2			1,5	18/18	0,81	<b>P2LDXN14EEHDDN</b>
	G1/8	Electric signal	Spring	3,2	15/45	0,22	<b>P2LAXN11ESHDDN</b>
	G1/4			3,2	20/55	0,38	<b>P2LBXN12ESHDDN</b>
	G3/8			3,2	25/85	0,76	<b>P2LCXN13ESHDDN</b>
	G1/2			3,2	25/85	0,76	<b>P2LDXN14ESHDDN</b>
<b>5/3 valves, external air to pilot operators</b>							
	G1/8	Electric signal	Electric signal	3,5	18/50	0,28	<b>P2LAXP11EEHDDN</b>
	G1/4	Closed centre	Self	3,5	25/65	0,44	<b>P2LBXP12EEHDDN</b>
	G3/8	position	centring	3,5	30/90	1,11	<b>P2LCXP13EEHDDN</b>
	G1/2			3,5	30/95	1,11	<b>P2LDXP14EEHDDN</b>
	G1/8	Electric signal	Electric signal	3,5	18/50	0,28	<b>P2LAXR11EEHDDN</b>
	G1/4	Vented centre	Self	3,5	25/65	0,44	<b>P2LBXR12EEHDDN</b>
	G3/8	position	centring	3,5	30/90	1,11	<b>P2LCXR13EEHDDN</b>
	G1/2			3,5	30/95	1,11	<b>P2LDXR14EEHDDN</b>
	G1/8	Electric signal	Electric signal	3,5	18/50	0,28	<b>P2LAXQ11EEHDDN</b>
	G1/4	Pressurised	Self	3,5	25/65	0,44	<b>P2LBXQ12EEHDDN</b>
	G3/8	centre	centring	3,5	30/90	1,11	<b>P2LCXQ13EEHDDN</b>
	G1/2	position		3,5	30/95	1,11	<b>P2LDXQ14EEHDDN</b>

**Dimensions**

P2LAX... all  
 3/2 valves

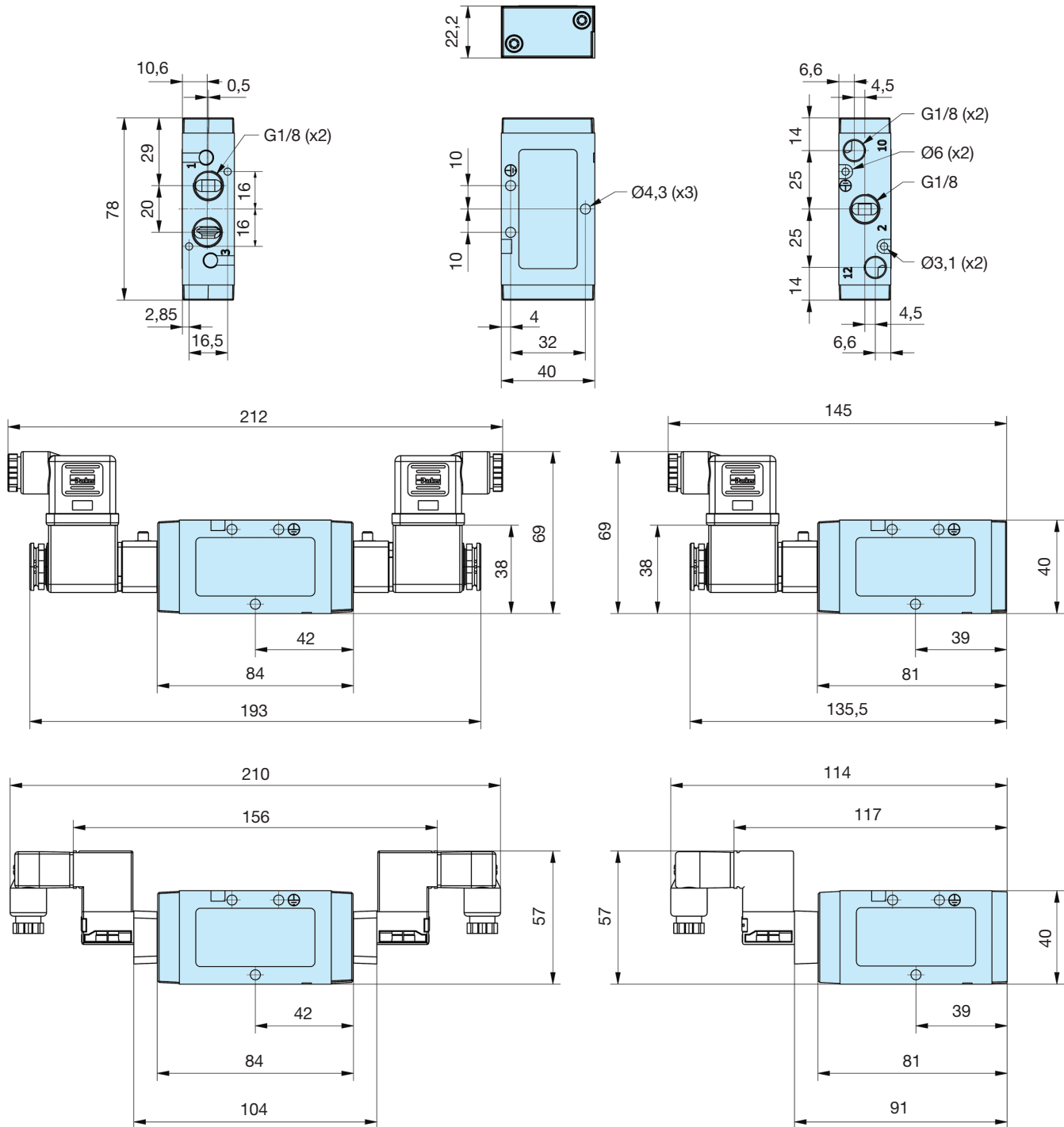

**Solenoid valves**  
 Cable plugs must be ordered separately.  
 One pilot valve is required for each E in the valve order code.



PDE2569TCUK

# Directional control valves

# Viking Xtreme

## Dimensions

P2LAX... all  
5/2 and 5/3 valves

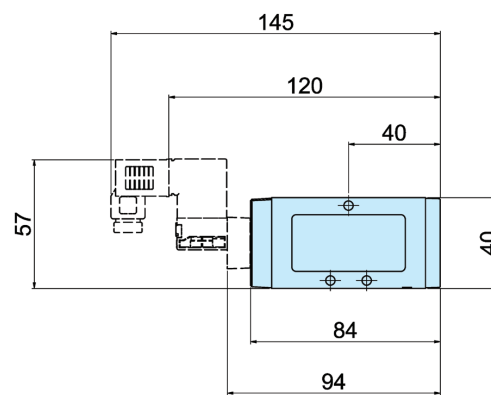
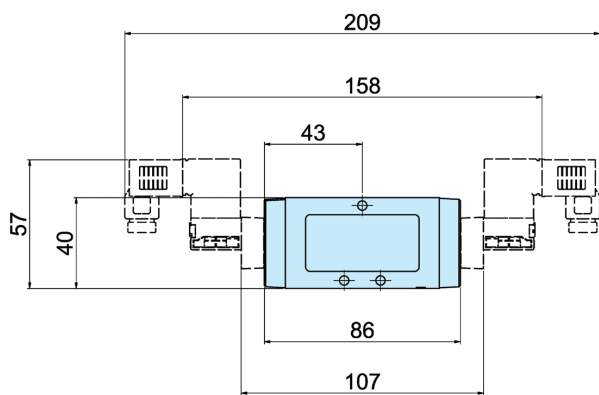
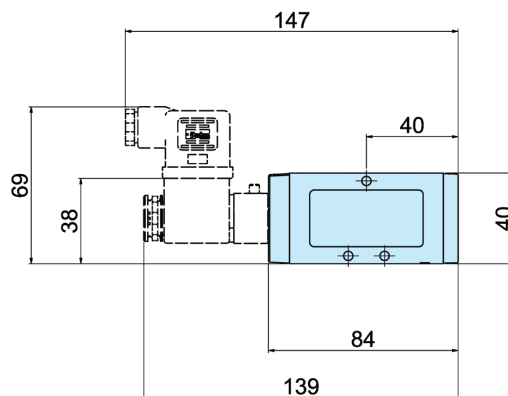
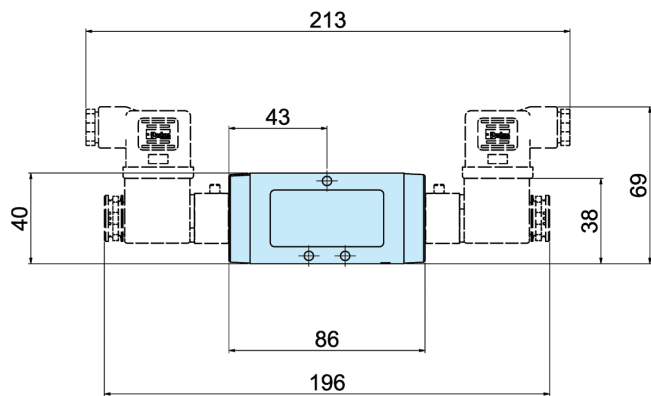
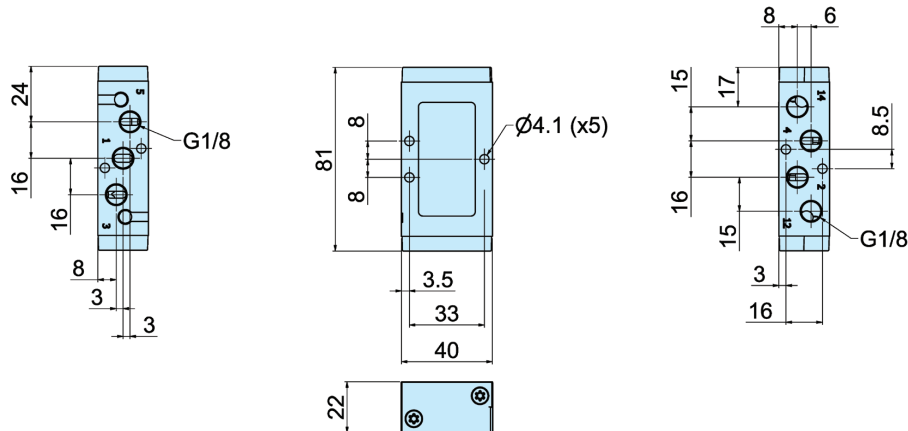

**Solenoid valves**  
 Cable plugs must be ordered separately.  
 One pilot valve is required for each E in the valve order code.





Dimensions

P2LAX - 3/2 Lever operated directional control valves

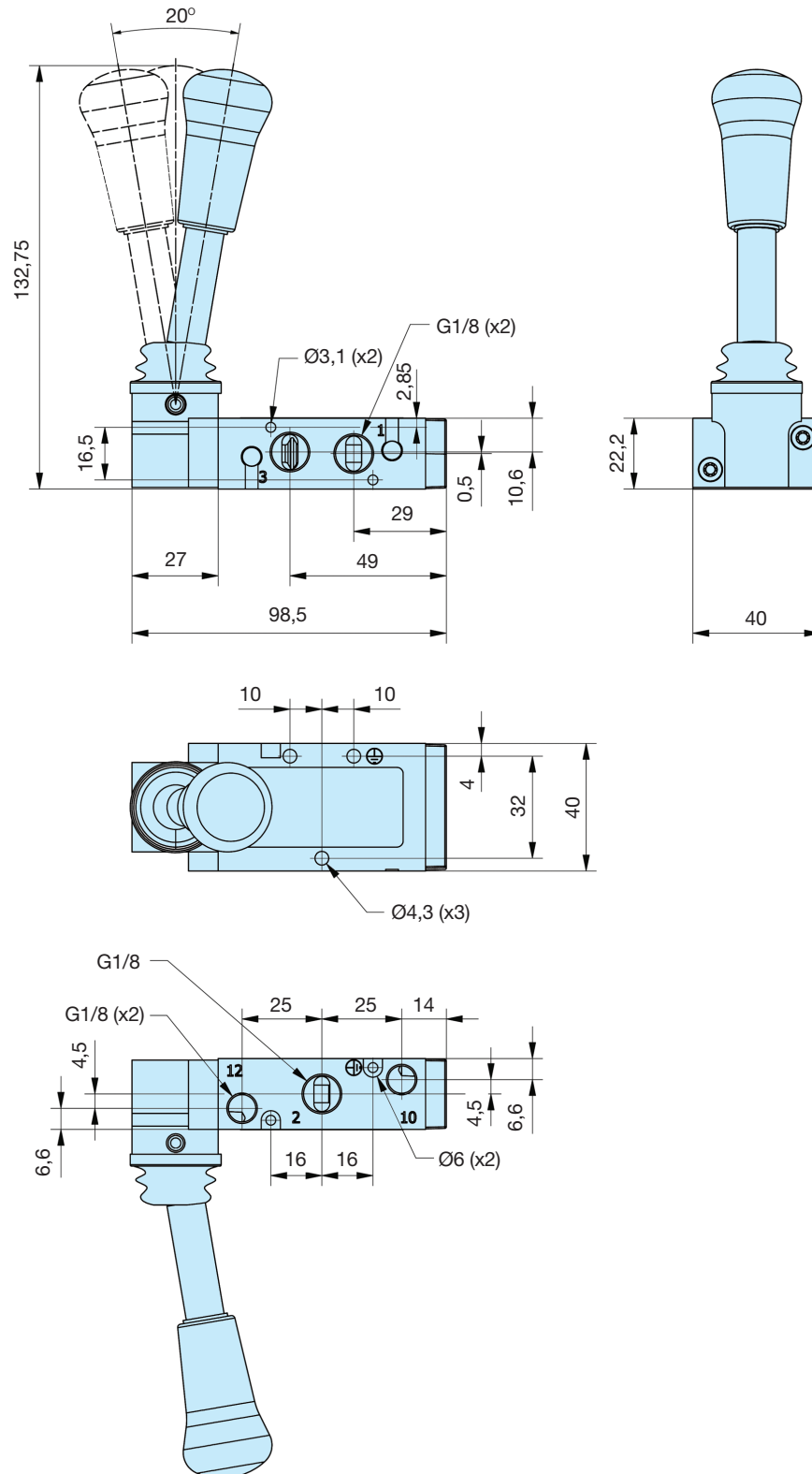



**Dimensions**

P2LAX - 5/2 & 5/3 Lever operated directional control valves

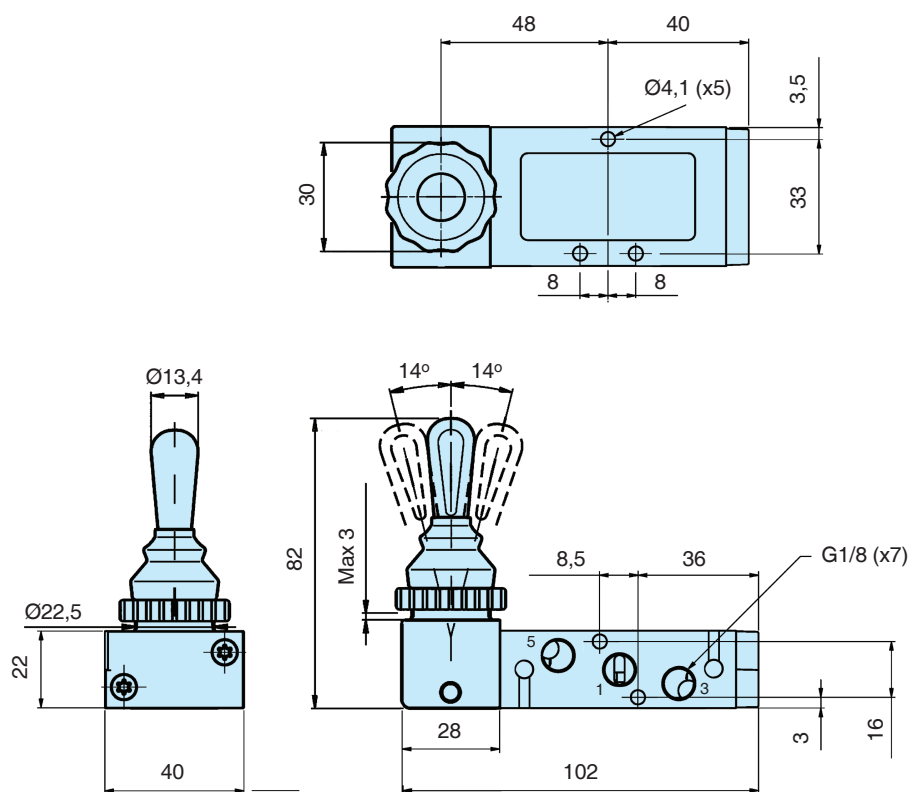





PDE2569TCUK  
**Directional control valves**

**Viking Xtreme**

**Dimensions**

**P2LBX - 5/2 Lever operated directional control valves**

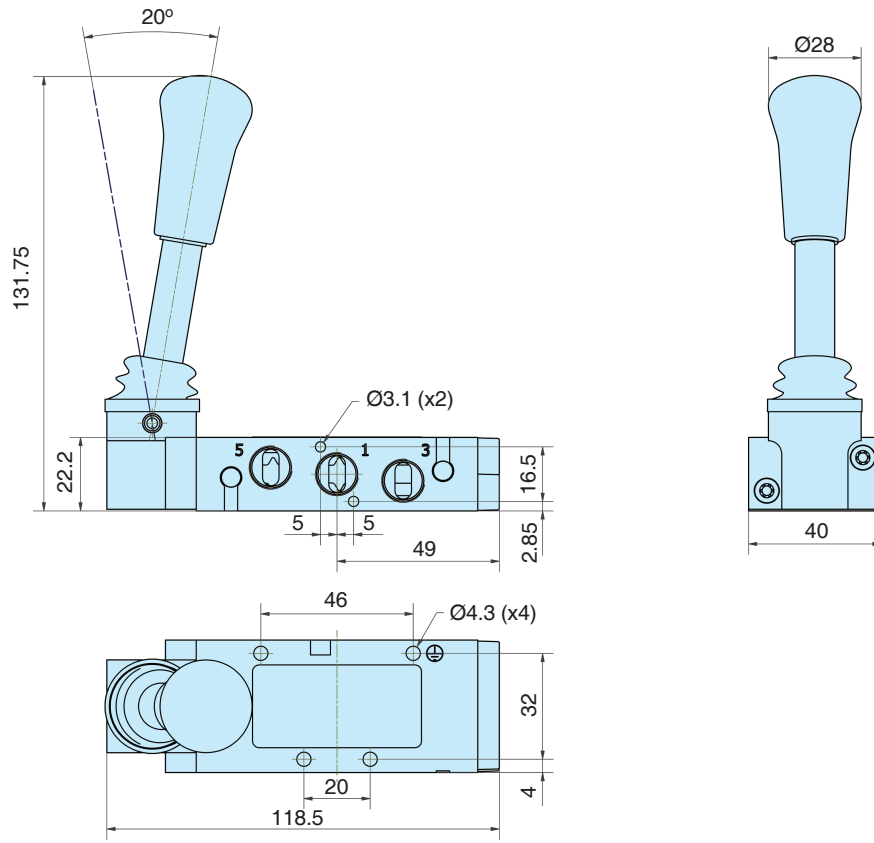

**P2LBX - 5/3 Lever operated directional control valves**

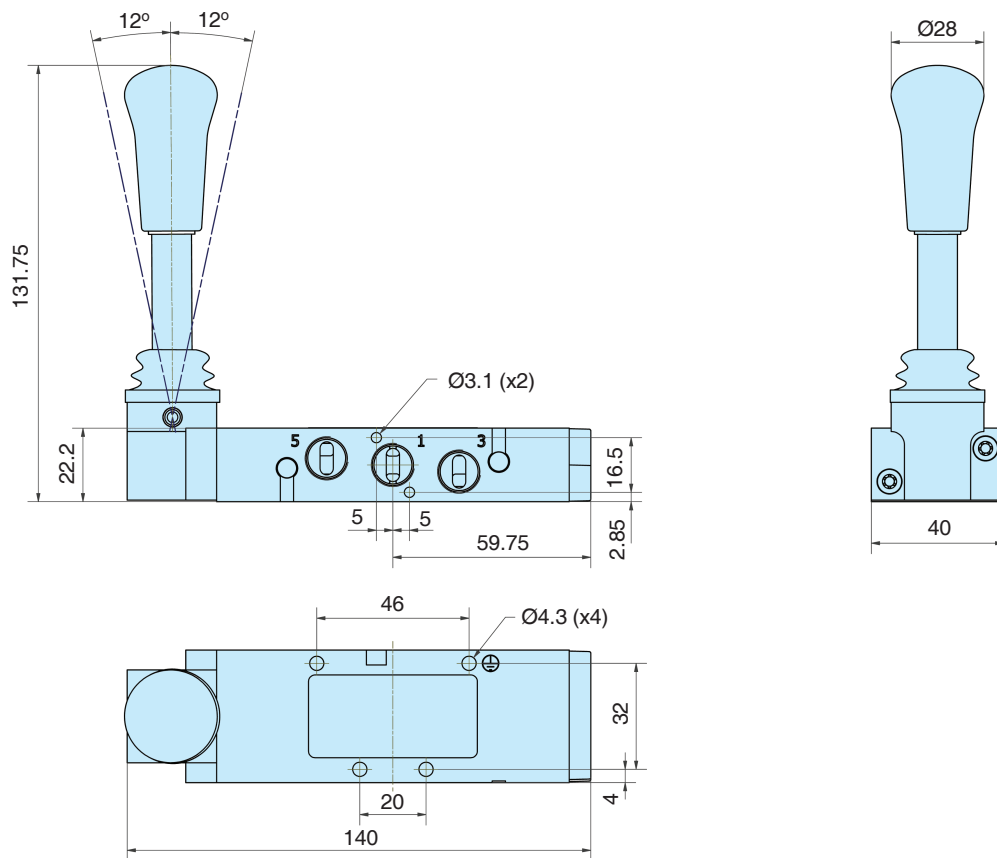



Dimensions

P2LCX - 3/2 Lever operated directional control valves

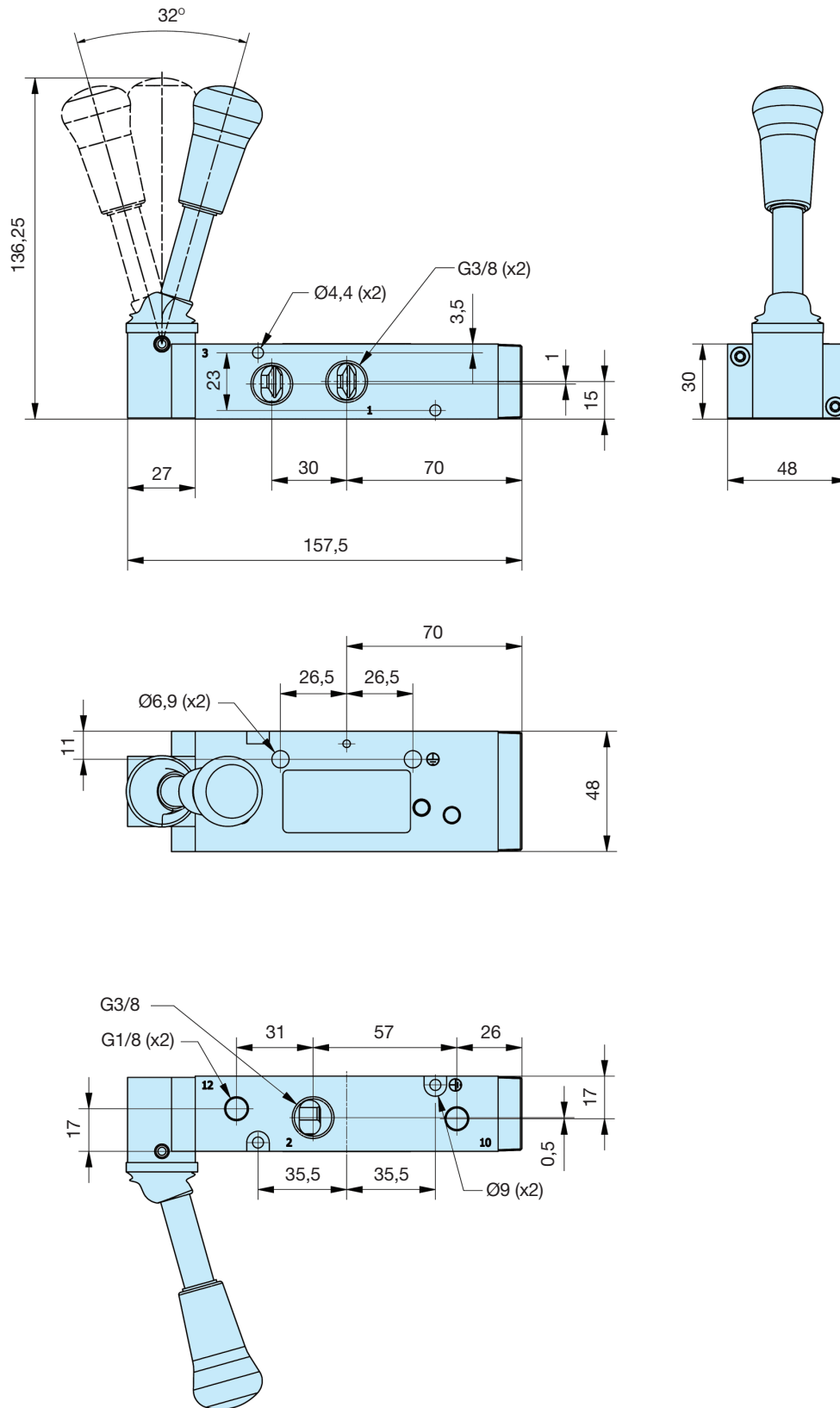



PDE2569TCUK

## Directional control valves

## Viking Xtreme

### Dimensions

#### P2LCX - 5/2 Lever operated directional control valves

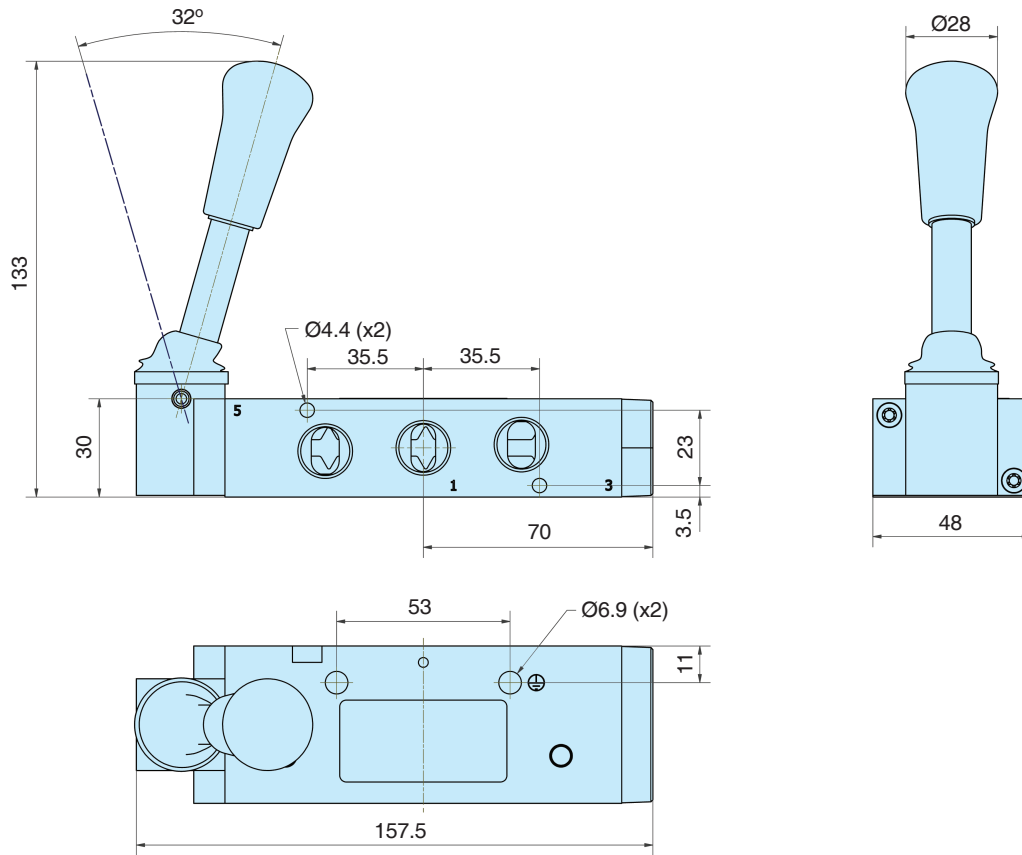

#### P2LCX - 5/3 Lever operated directional control valves

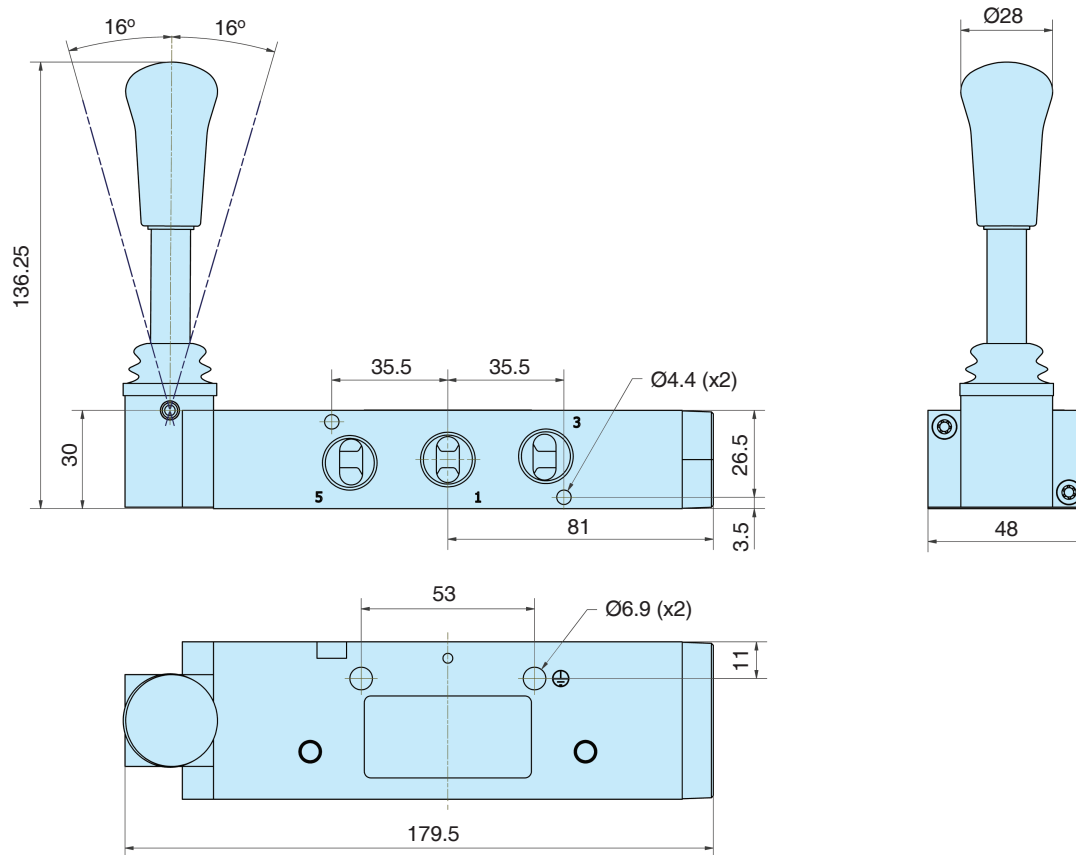

**Dimensions**

**P2LDX - 3/2 Lever operated directional control valves**

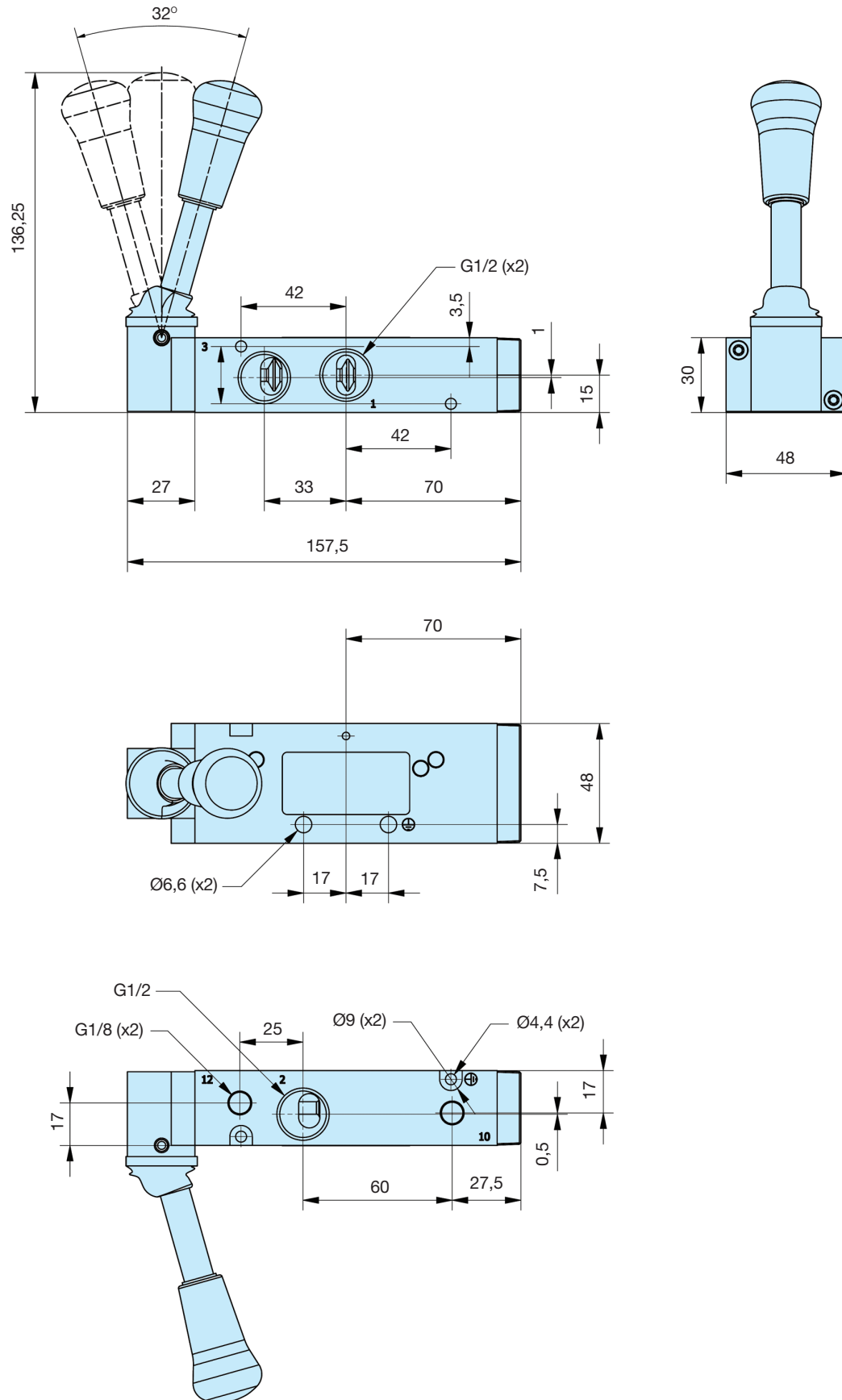



PDE2569TCUK

### Directional control valves

Viking Xtreme

### Dimensions

P2LDX - 5/2 Lever operated directional control valves

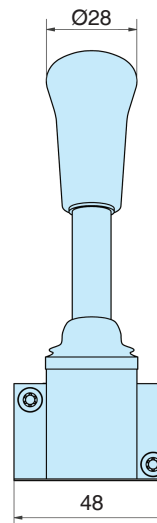
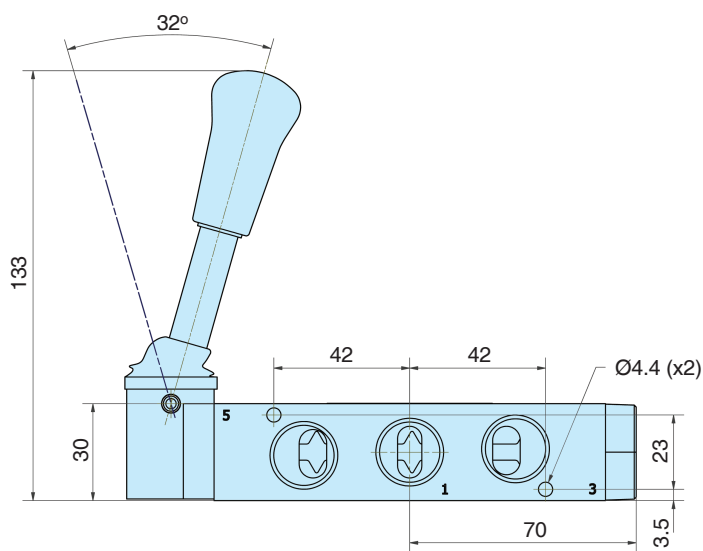

P2LDX - 5/3 Lever operated directional control valves

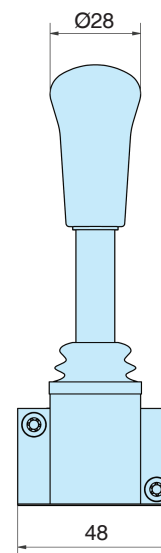
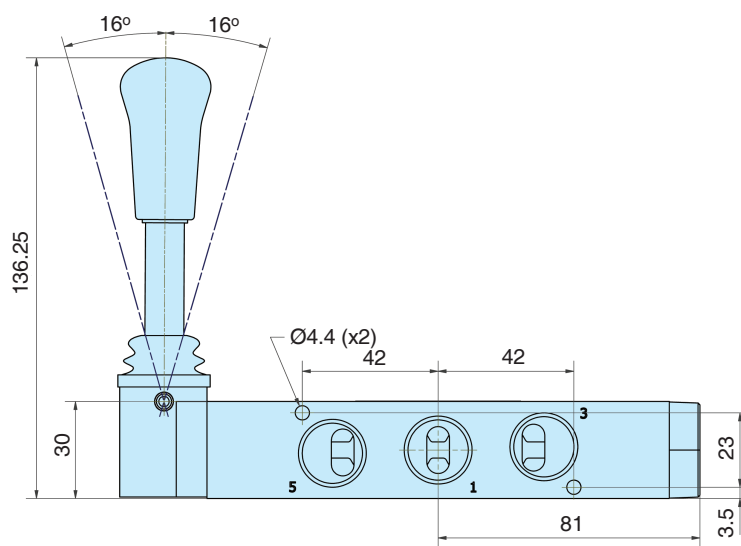



**Dimensions**

**P2LBX - 3/2 Twist operated directional control valves**

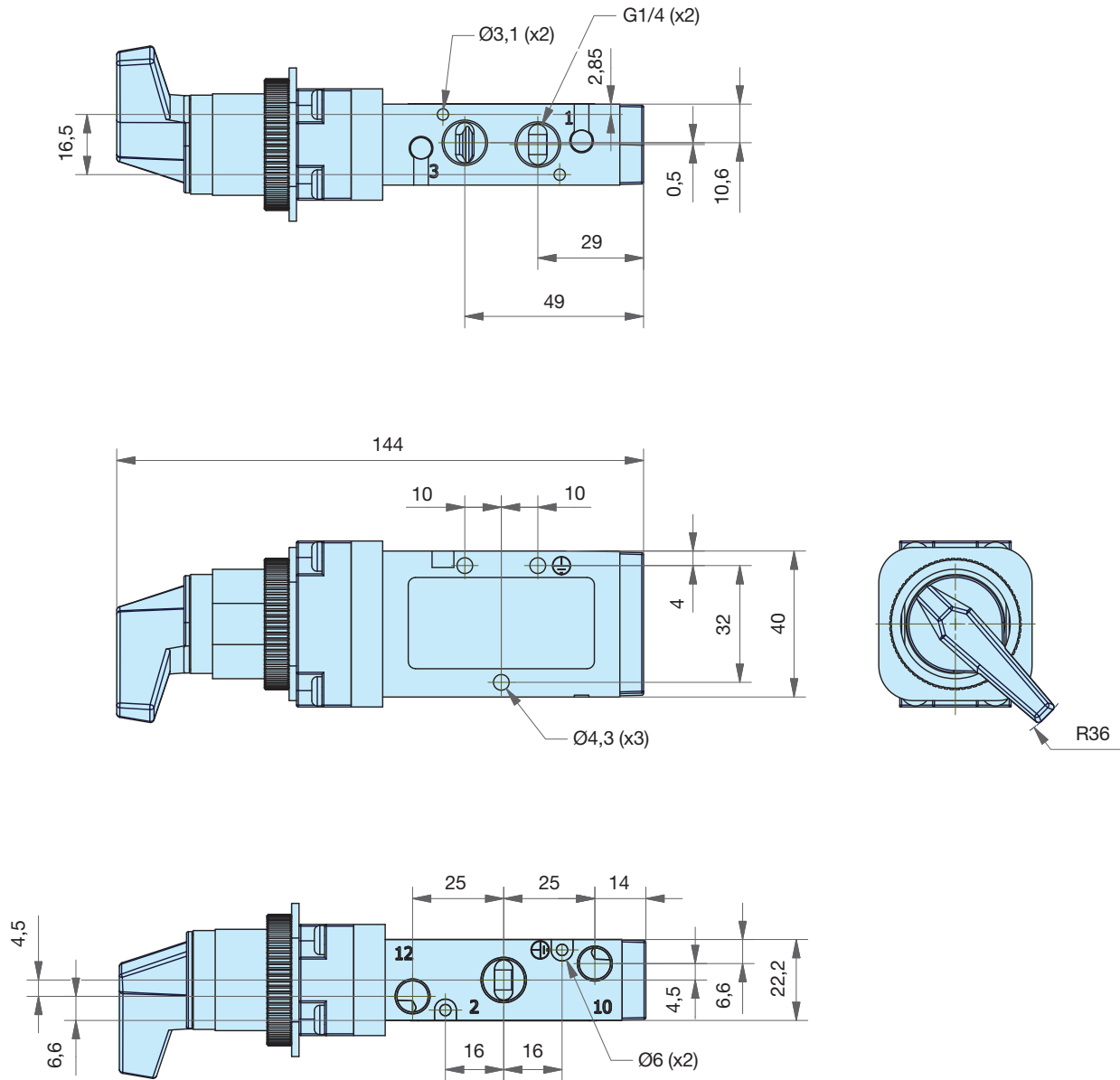

**Panel cut-out details**

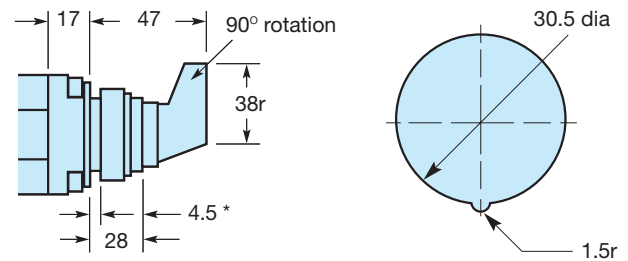

\* Max panel thickness



PDE2569TCUK  
**Directional control valves**

**Viking Xtreme**

**Dimensions**

P2LBX - 5/2 Twist operated directional control valves

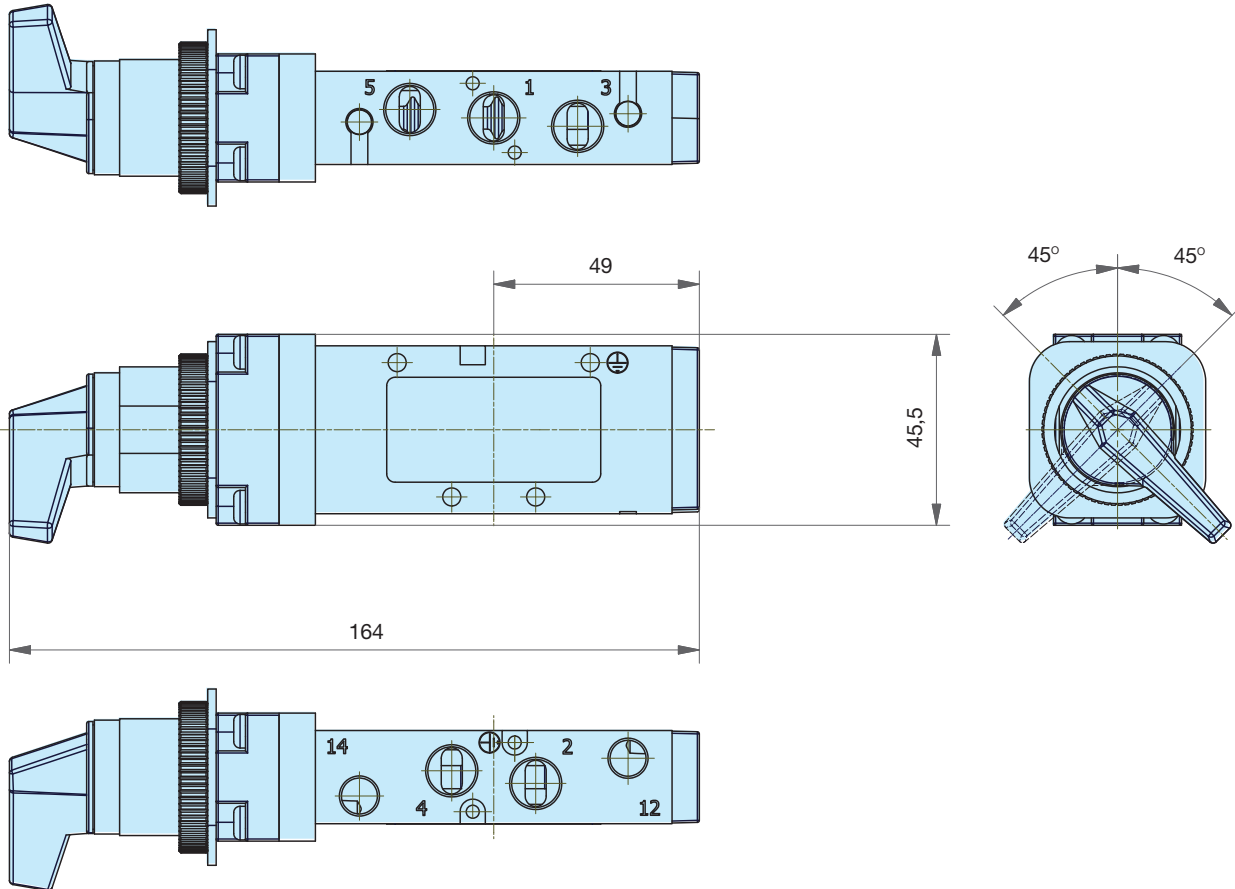

Dimensions

P2LBX - 5/3 Twist operated directional control valves

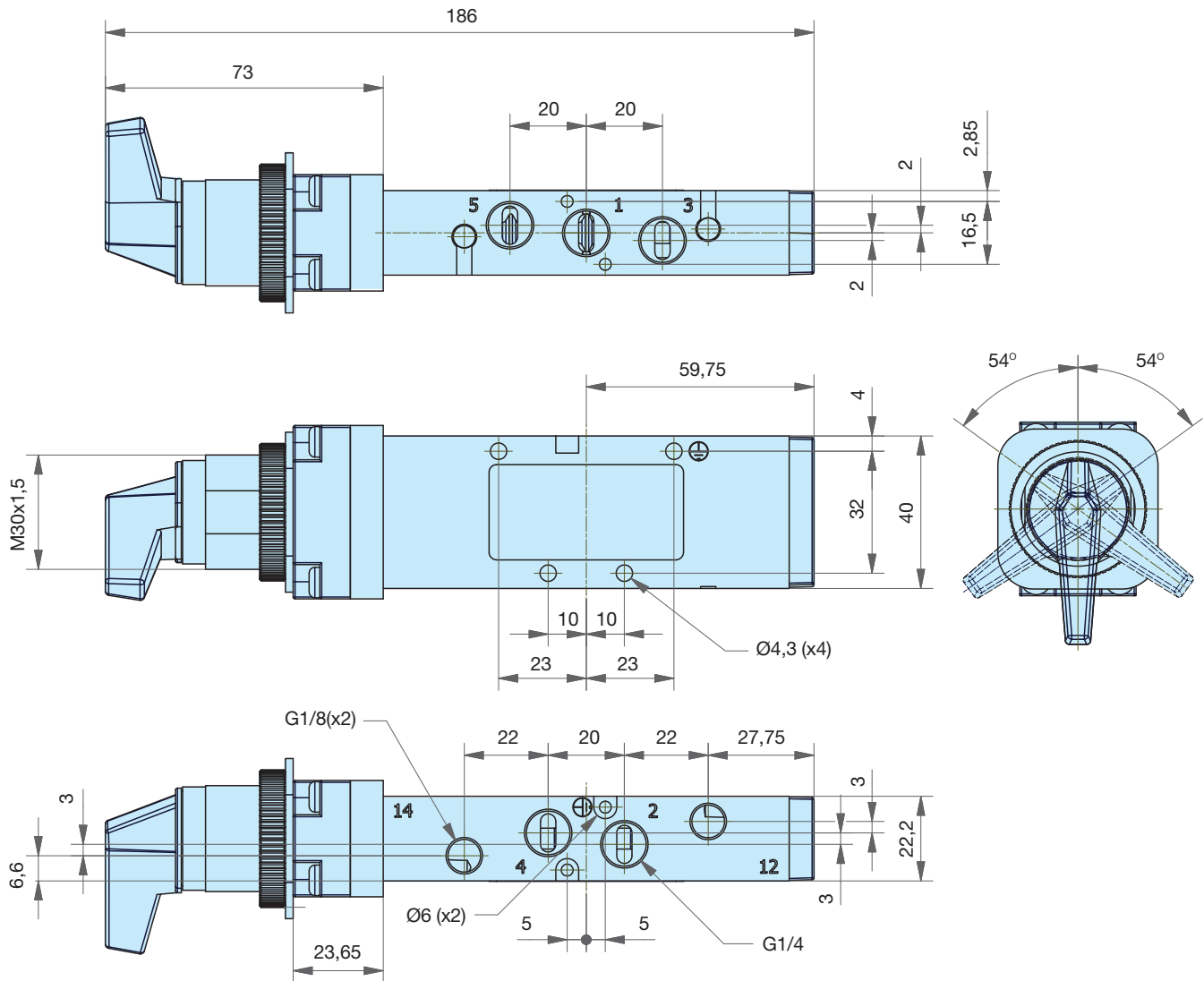



**Dimensions**

P2LBX - 3/2 Lever

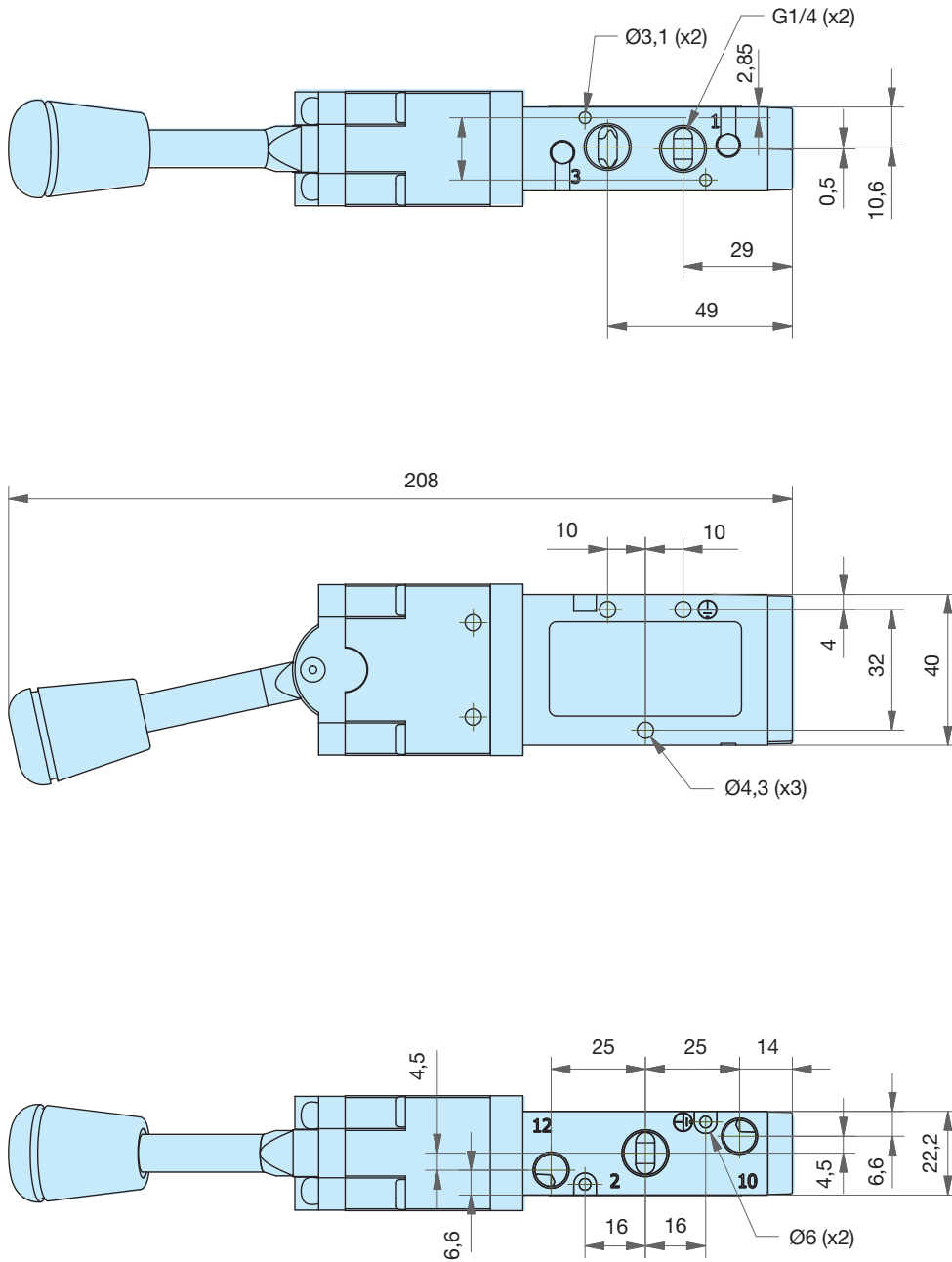



**Dimensions**

P2LBX - 5/2 Lever

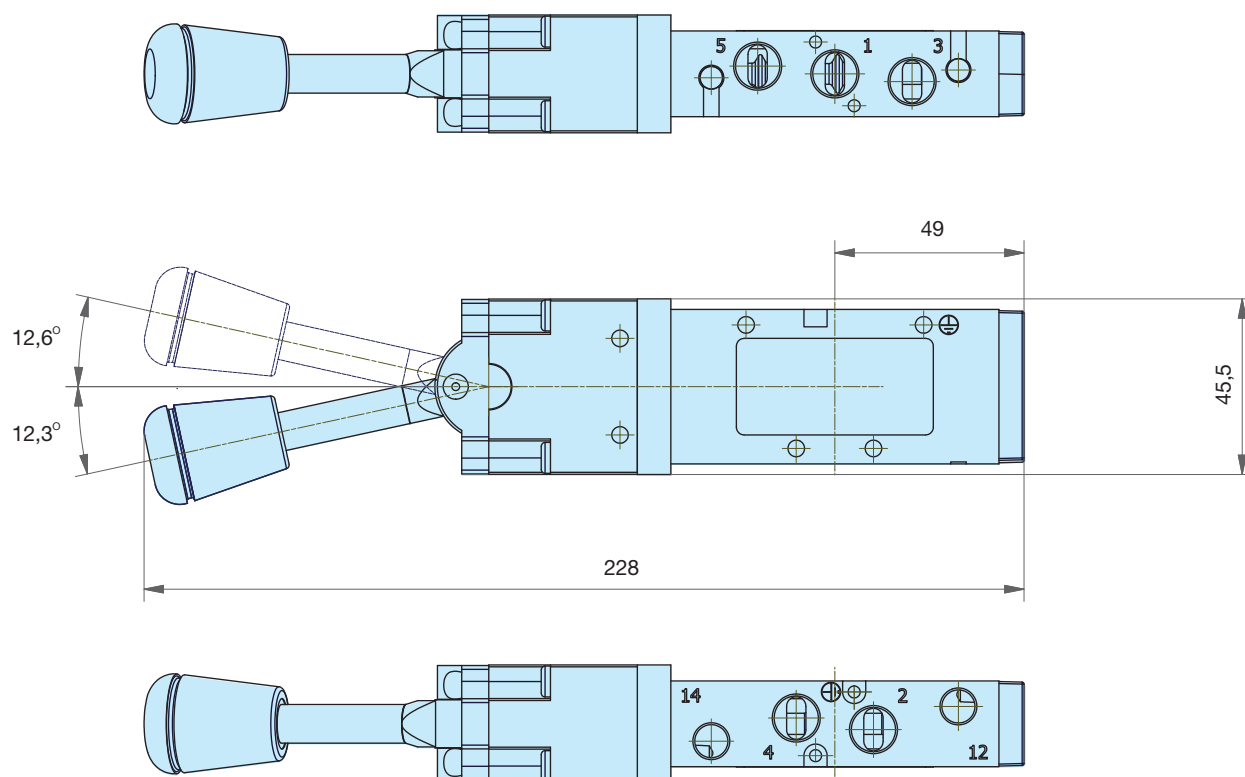





**Dimensions**

P2LBX... all  
 3/2 valves

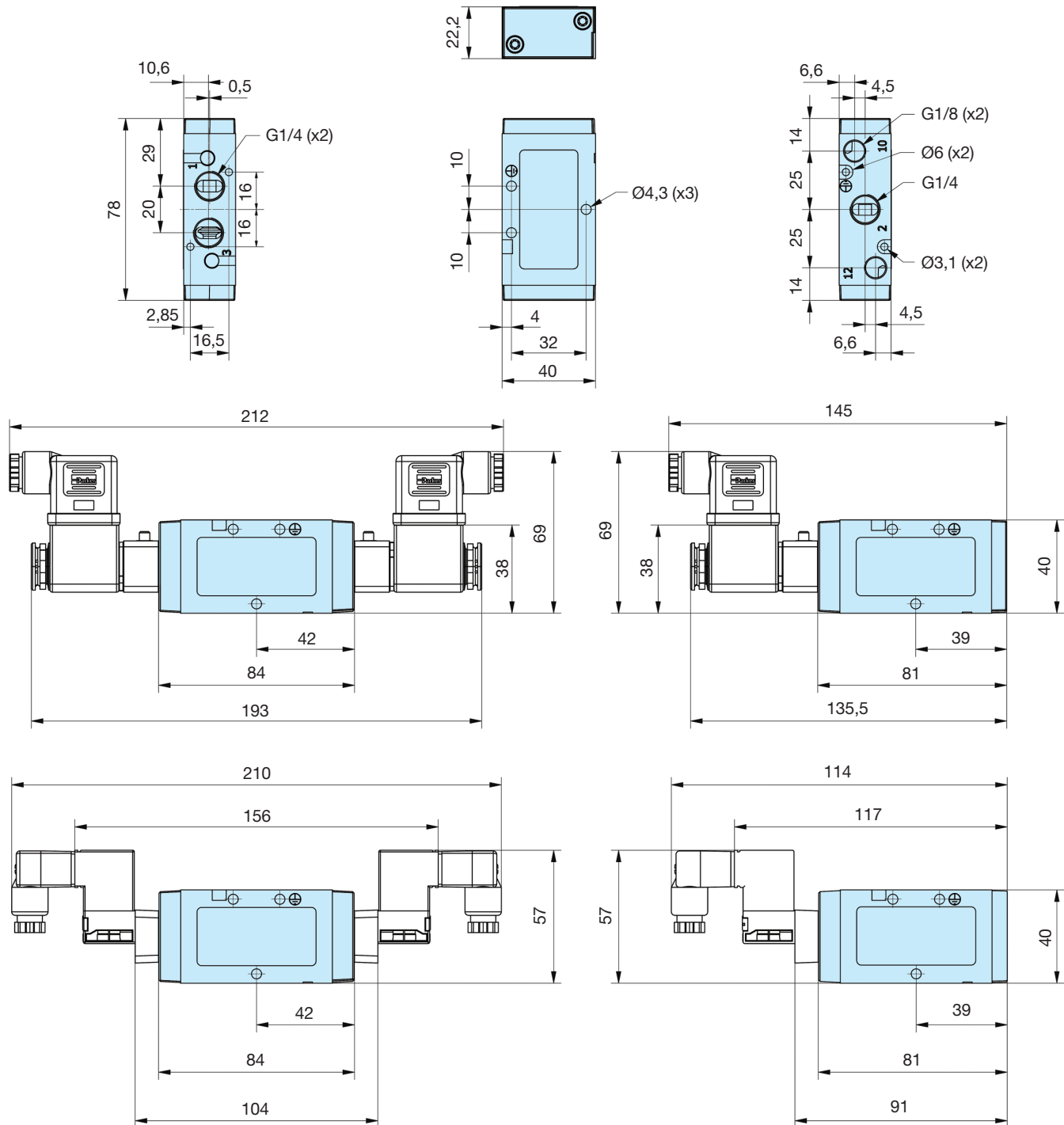



PDE2569TCUK

# Directional control valves

# Viking Xtreme

## Dimensions

P2LBX... all

5/2 and 5/3 valves

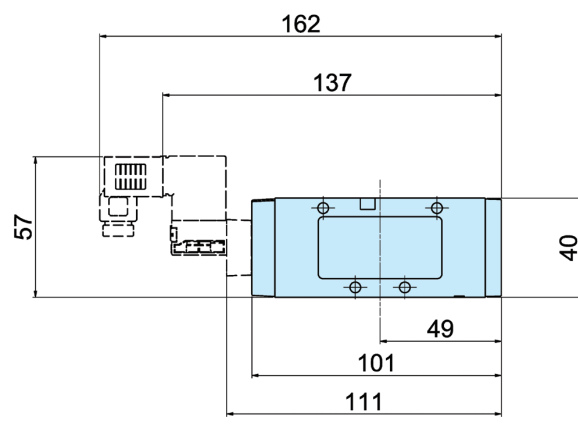
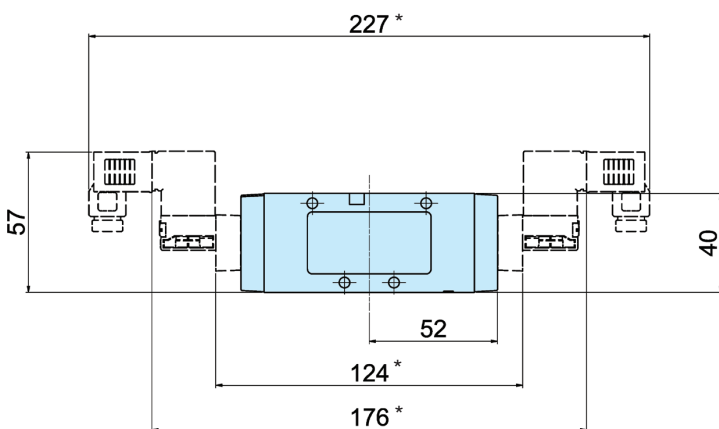
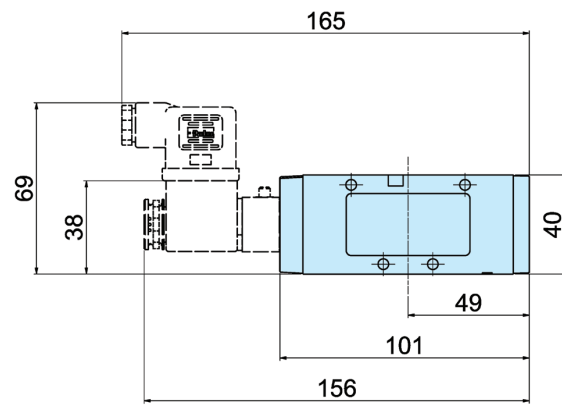
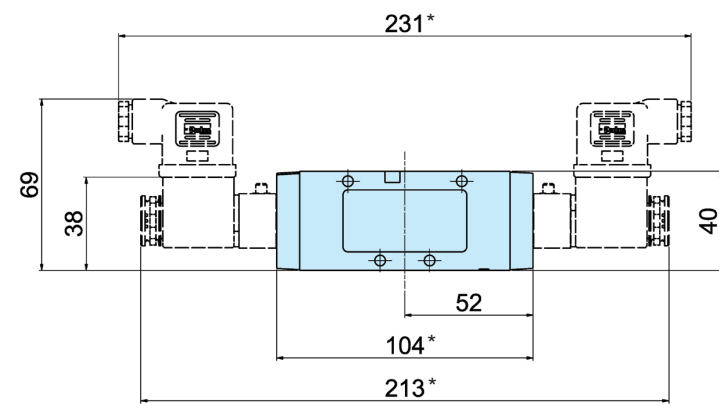
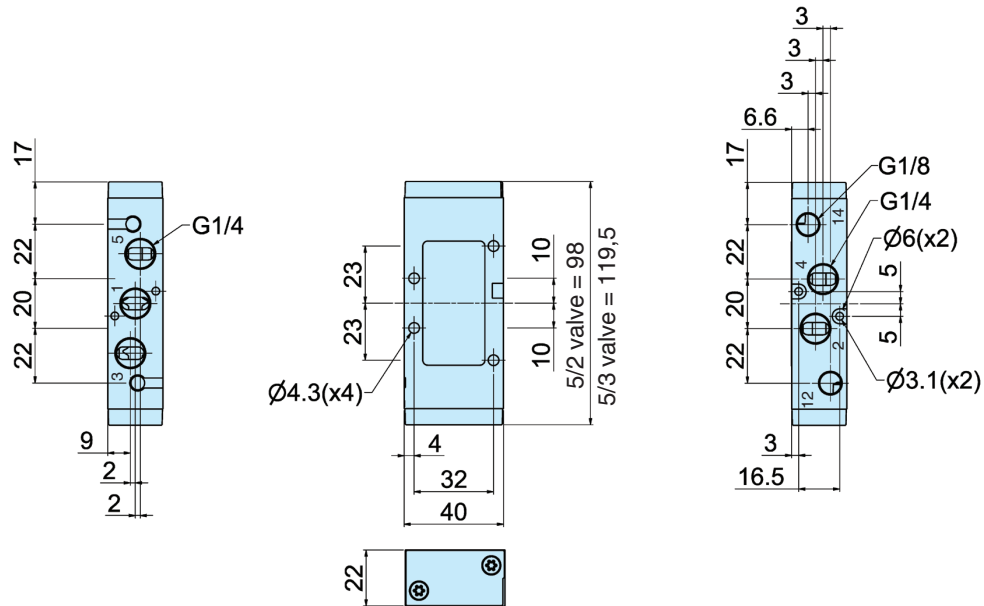

\* Note: 5/3 valves - add 21.5mm



**Dimensions**

NAMUR  
 5/2 valves

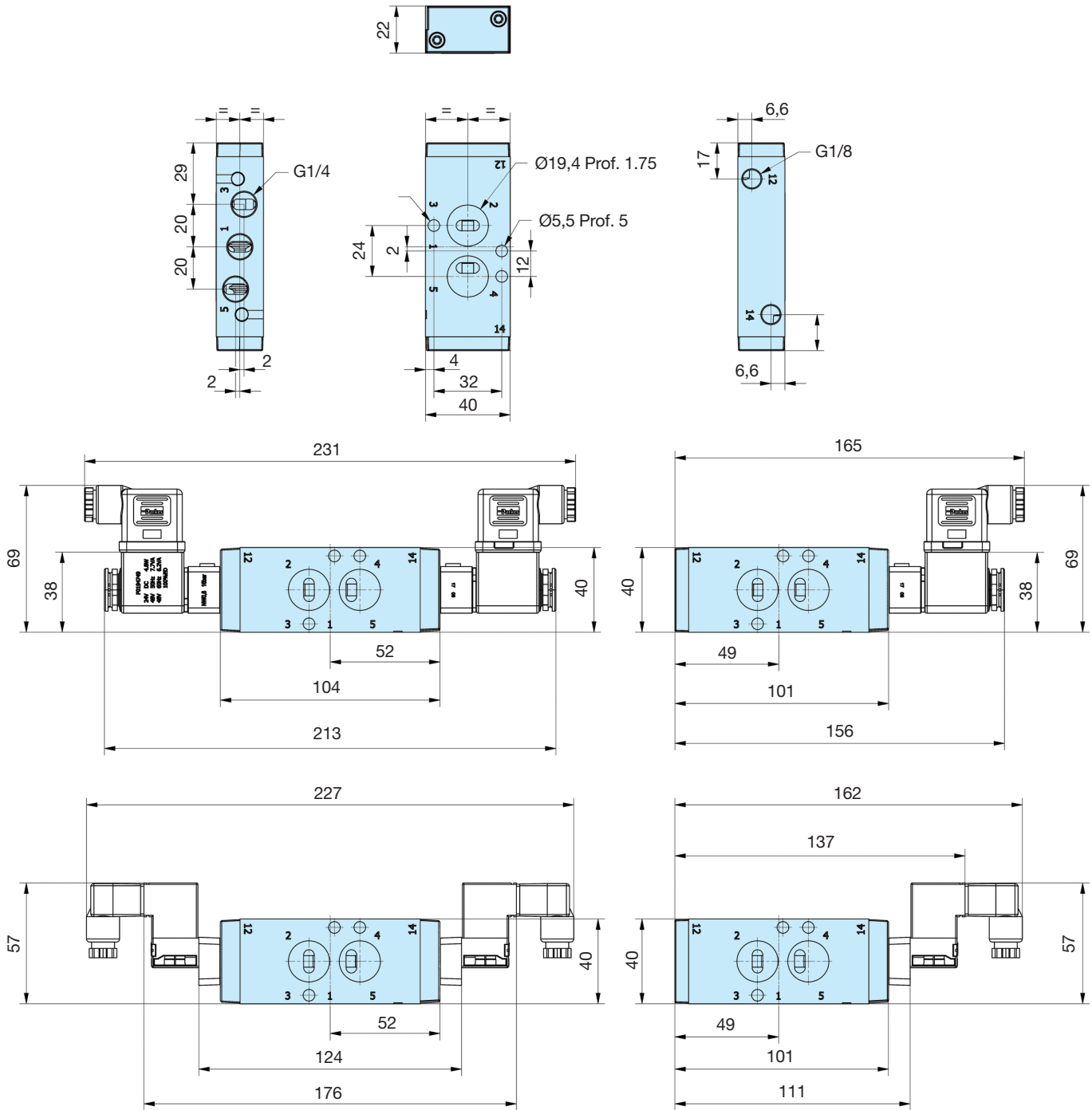



PDE2569TCUK  
**Directional control valves**

**Viking Xtreme**

**Dimensions**

P2LCX... all  
 3/2 valves

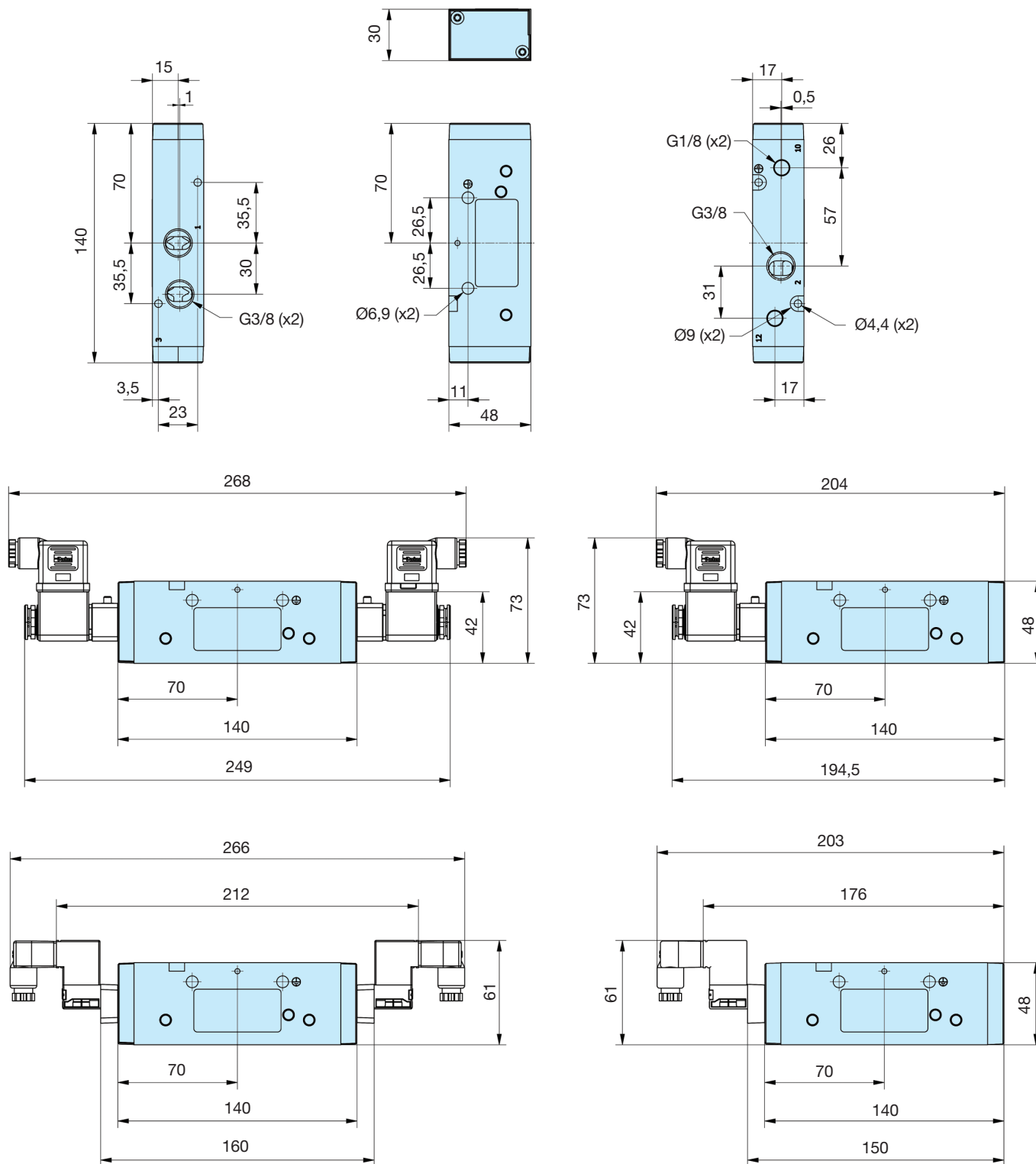



**Dimensions**

P2LCX... all  
 5/2 and 5/3 valves

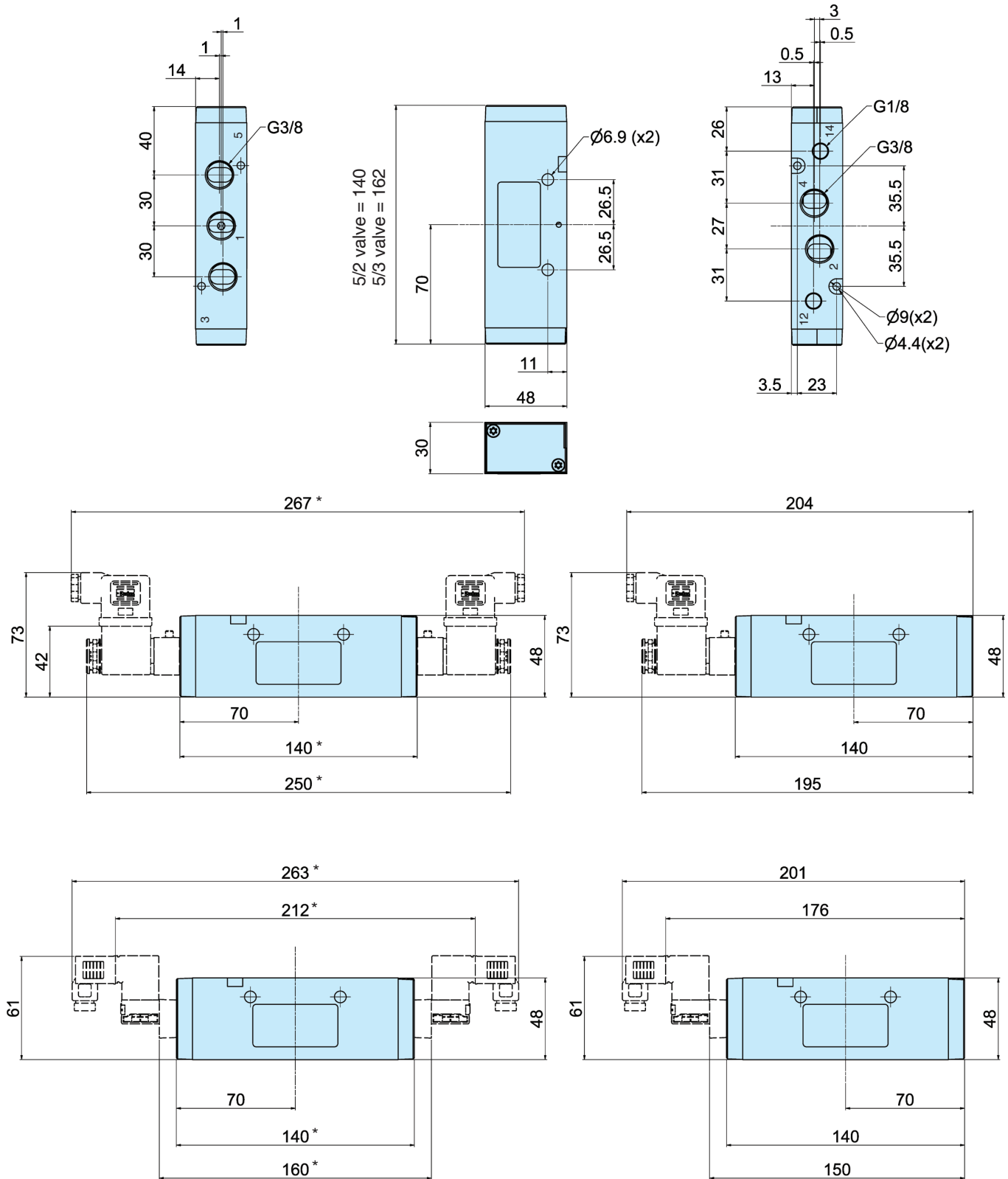

\* Note: 5/3 valves - add 22.0mm



PDE2569TCUK  
**Directional control valves**

**Viking Xtreme**

**Dimensions**

P2LDX... all  
 3/2 valves

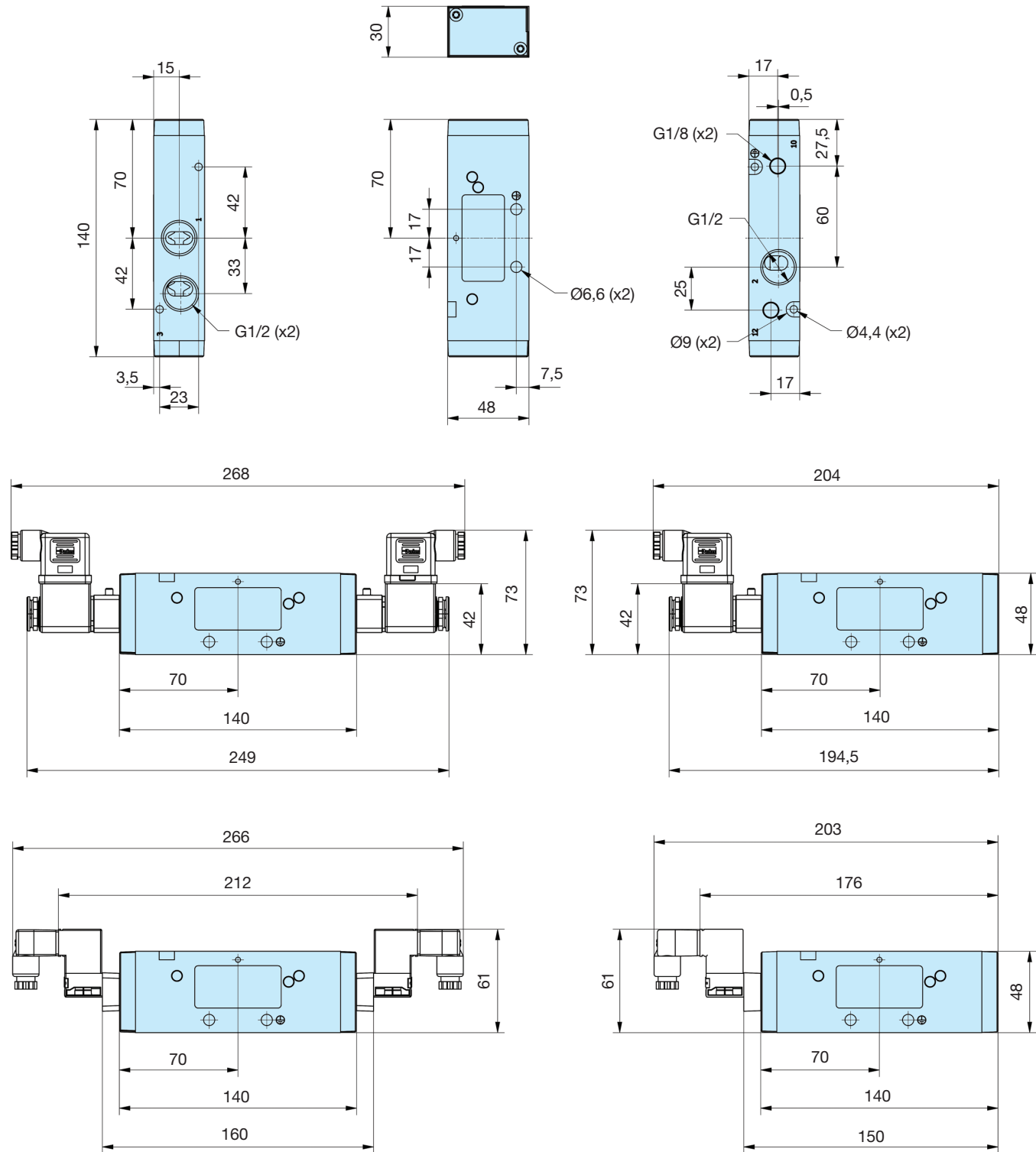

**Dimensions**

P2LDX... all  
 5/2 and 5/3 valves

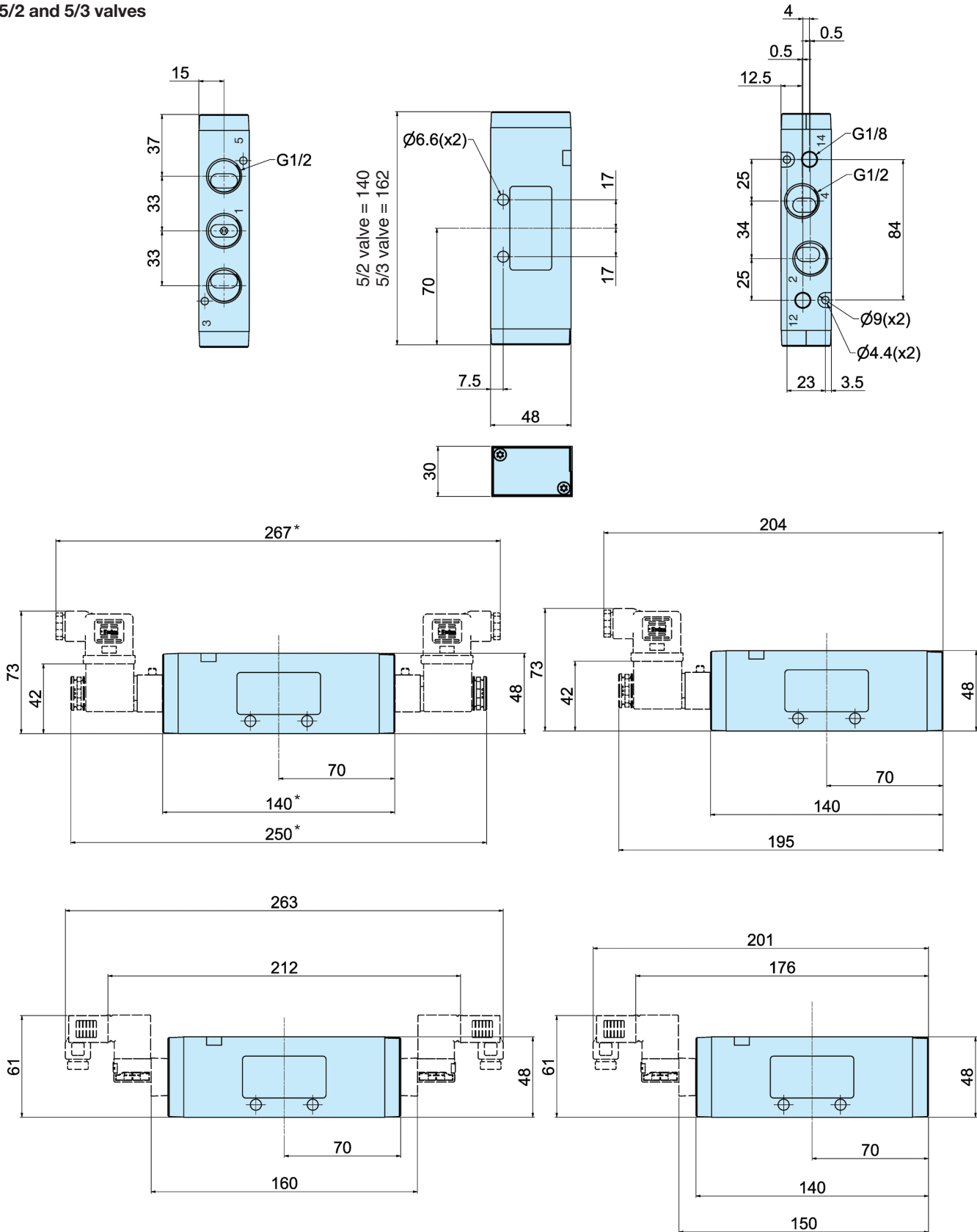

\* **Note:** 5/3 valves - add 22.0mm



PDE2569TCUK  
**Directional control valves**

**Viking Xtreme**

**Dimensions**

**NAMUR**  
**5/2 and 5/3 valves**

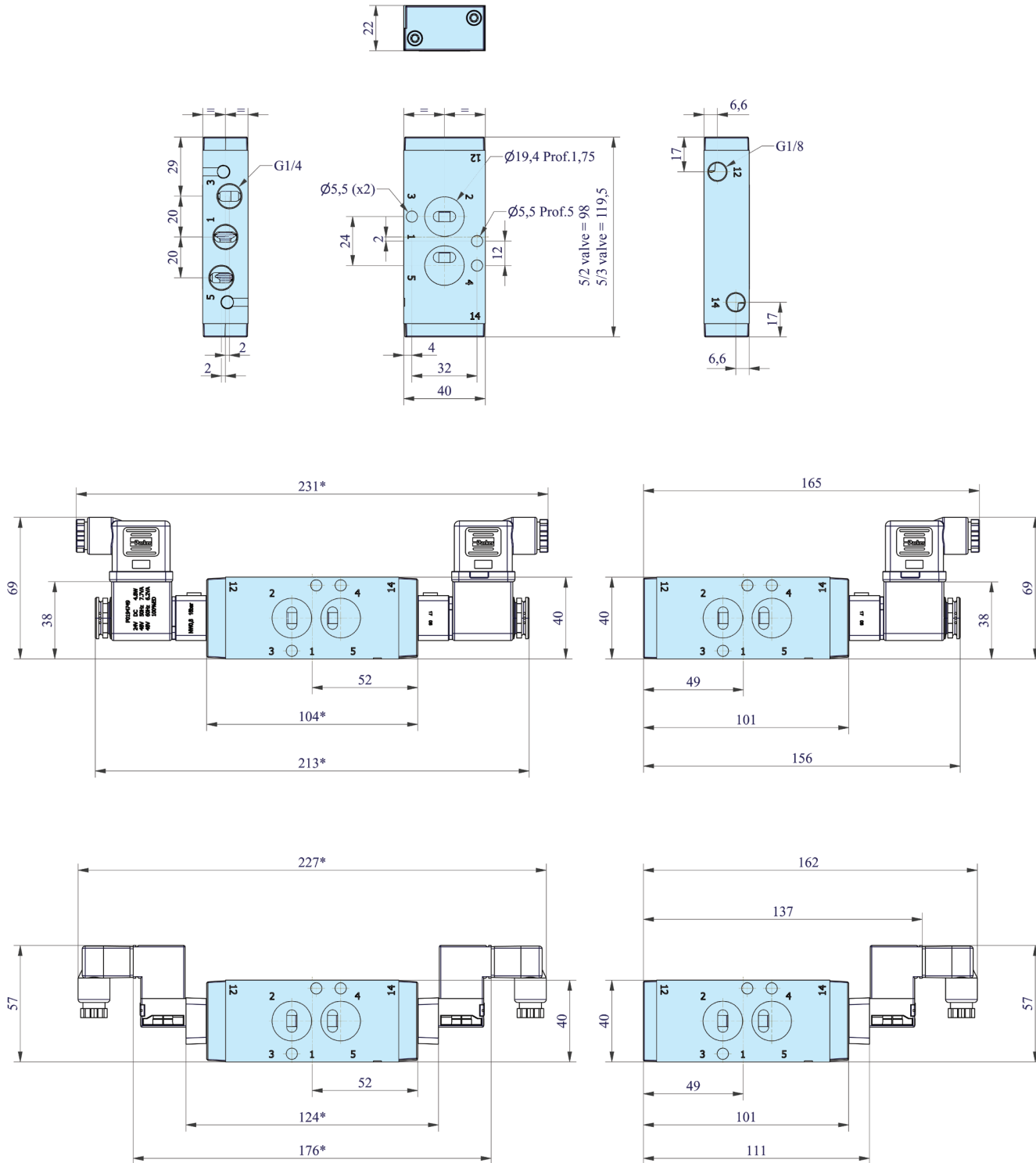

**P2LAX, flexible manifold assembly**

A practical system solution with the aid of connection pieces. The manifolds can easily be assembled from the top to form a compact and stable block. The block can then be installed in cabinets or directly on the machine frame as shown in the example in the bottom of this page.

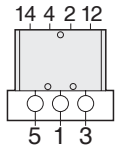

**Valve:**  
with cylinder ports 2 and 4 and signal ports 12 and 14 facing upwards, enabling easily access to connection ports. All ports are G1/8 threaded to simplify choice of connectors.

**Manifold:**  
with common channels for ports 1, 3 and 5.

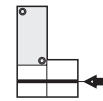
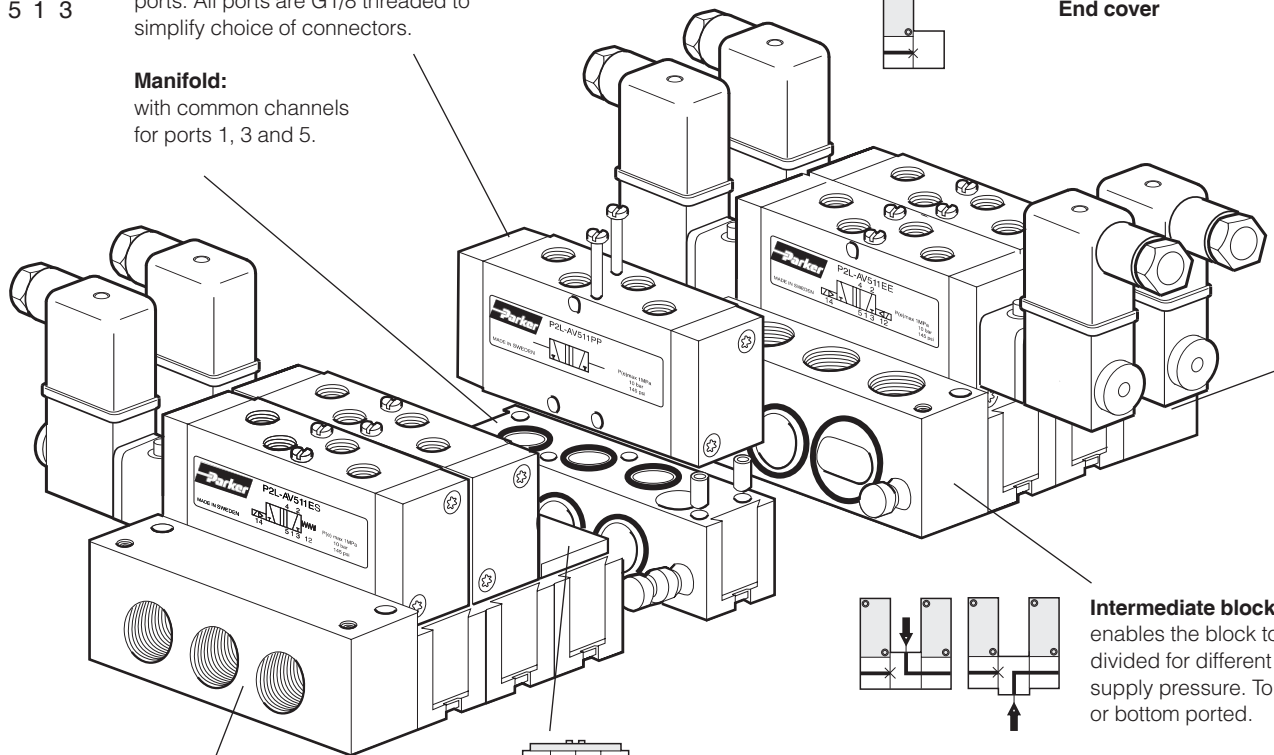

**Connection block S:**  
straight connection block with a side ports for common air supply and exhaust.

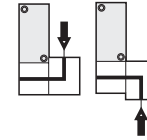

**Connection block L:**  
angled connection block for top or bottom ported.



**End cover**

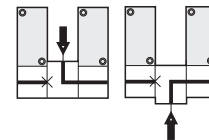

**Intermediate block L:**  
enables the block to be divided for different supply pressure. Top or bottom ported.

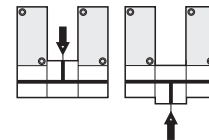

**Intermediate block T:**  
permits the connection of air between two manifolds. Top or bottom ports.

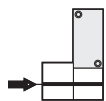

**Connection block S:**  
straight connection block with a side ports for common air supply and exhaust.

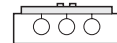

**Blanking plate:**  
To incorporate spare positions.

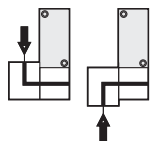

**Connection block L:**  
angled connection block for top or bottom ported.



**End cover**

**Various mounting options**

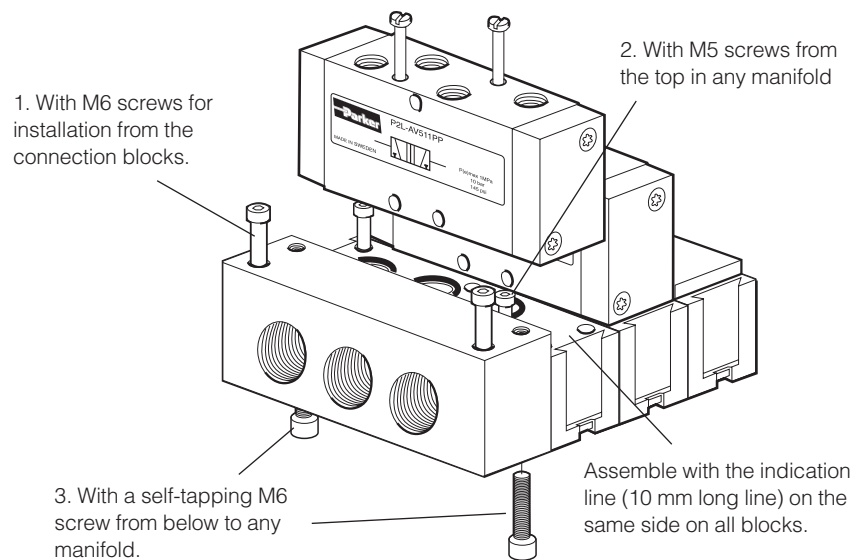

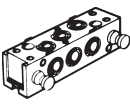
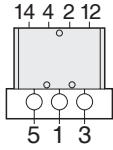
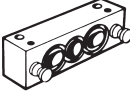
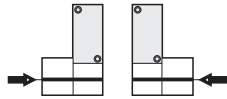
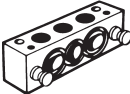
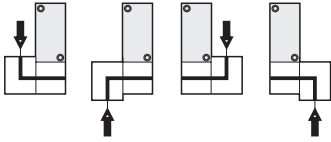
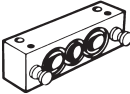
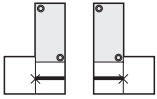
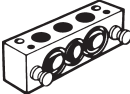
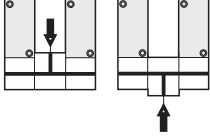
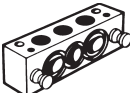
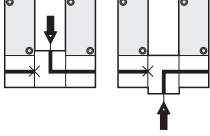
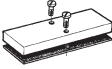
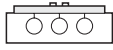
Accessories P2LA	Connection alternatives	Type	Weight kg	Order code
		<b>Multiple manifold</b> including seals, mounting screws, and guiding pins.	0,11	<b>9121658060</b>
		<b>Connection block S</b> including seals, mounting screws, and guiding pins. G1/4	0,15	<b>9121658064</b>
		<b>Connection block L</b> including seals, mounting screws, and guiding pins. G1/4	0,15	<b>9121658061</b>
		<b>End cover</b> including seals, mounting screws, and guiding pins.	0,16	<b>9121658066</b>
		<b>Intermediate block T</b> including seals, mounting screws, and guiding pins. G1/4	0,17	<b>9121658062</b>
		<b>Intermediate block L</b> including seals, mounting screws, and guiding pins. G1/4	0,17	<b>9121658065</b>
		<b>Blanking plate</b> including seals, mounting screws.	0,05	<b>9121658063</b>



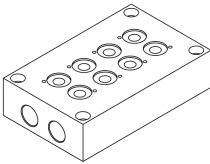
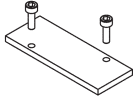

Accessories	Type P2LA / P2LB 3/2 valves	Weight kg	Order code
	<b>Manifold bar, P2LA/P2LB (not for P2LB with external air supply to solenoid valves)</b> incl. fasteners and O-ring. G3/8		
	For 2 valves	0,69	<b>91213202SXZ</b>
	For 4 valves	1,13	<b>91213204SXZ</b>
	For 6 valves	1,56	<b>91213206SXZ</b>
	For 8 valves	2,00	<b>91213208SXZ</b>
	For 10 valves	2,45	<b>91213210SXZ</b>
	<b>Blanking plate</b> for Manifold bar	0,10	<b>912132BPSXZ</b>

**Dimensions**

**Manifold bar**

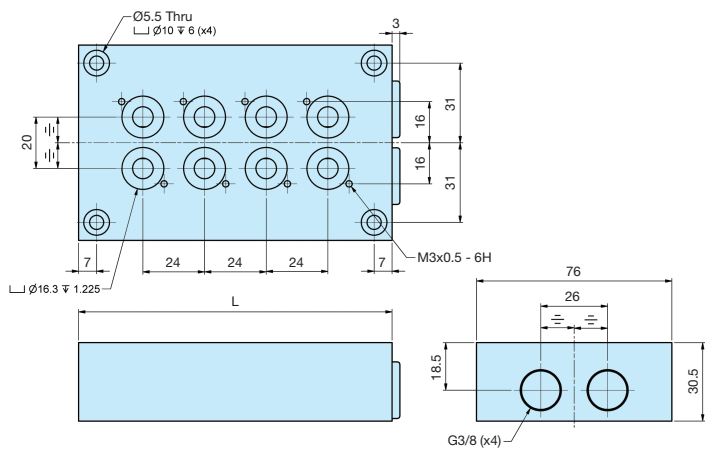

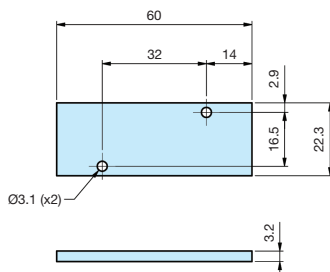

No. of valves	L mm
2	74
4	122
6	170
8	218
10	266

**Blanking plate for manifold bar, P2LB**



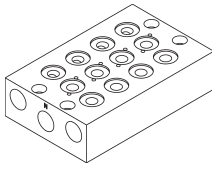
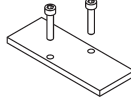
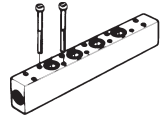
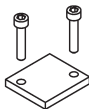

Accessories P2LB	Type	Weight kg	Order code
	<b>Manifold bar, P2LB, (not for P2LB with external air supply to solenoid valves)</b> incl. fasteners and O-ring. G3/8 For 2 valves For 4 valves For 6 valves For 8 valves For 10 valves	0,69 1,13 1,56 2,00 2,45	<b>9121594805X</b> <b>9121594806X</b> <b>9121594807X</b> <b>9121594808X</b> <b>9121594812X</b>
	<b>Blanking plate, P2LBX</b> for Manifold bar	0,10	<b>9121594809X</b>
	<b>Pressure bar, P2LBX</b> for common air supply incl. O-rings and mounting screws. G3/8 For 2 valves For 4 valves For 6 valves For 8 valves For 10 valves	0,38 0,53 0,68 0,83 0,99	<b>9127113301X</b> <b>9127113302X</b> <b>9127113303X</b> <b>9127113304X</b> <b>9127113305X</b>
	<b>Blanking plate P2LBX</b> for Pressure bar. G1/4	0,02	<b>9127113306X</b>
	<b>Manifold Spares Kit P2LB</b> Manifold O-rings, Manifold and Blanking Plate Screws	0,04	<b>P2LB/MAN-KIT</b>

**Dimensions**

**Manifold bar, P2LB**

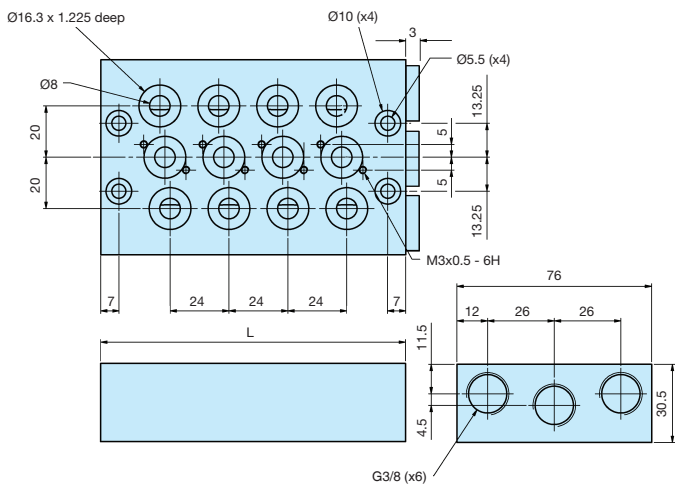

No. of valves	L mm
2	74
4	122
6	170
8	218
10	266

**Blanking plate for manifold bar, P2LB**

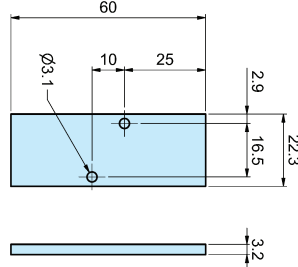

**Pressure bar, P2LB**

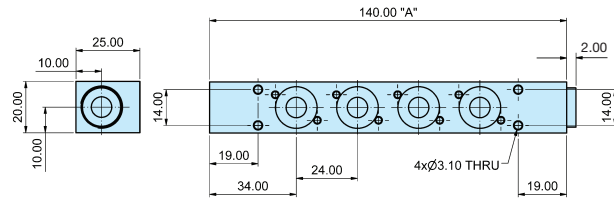

**Blanking plate for pressure bar, P2LB**

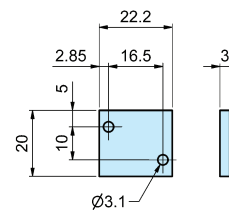

No. of valves	A mm
2	92
4	140
6	188
8	236
10	284



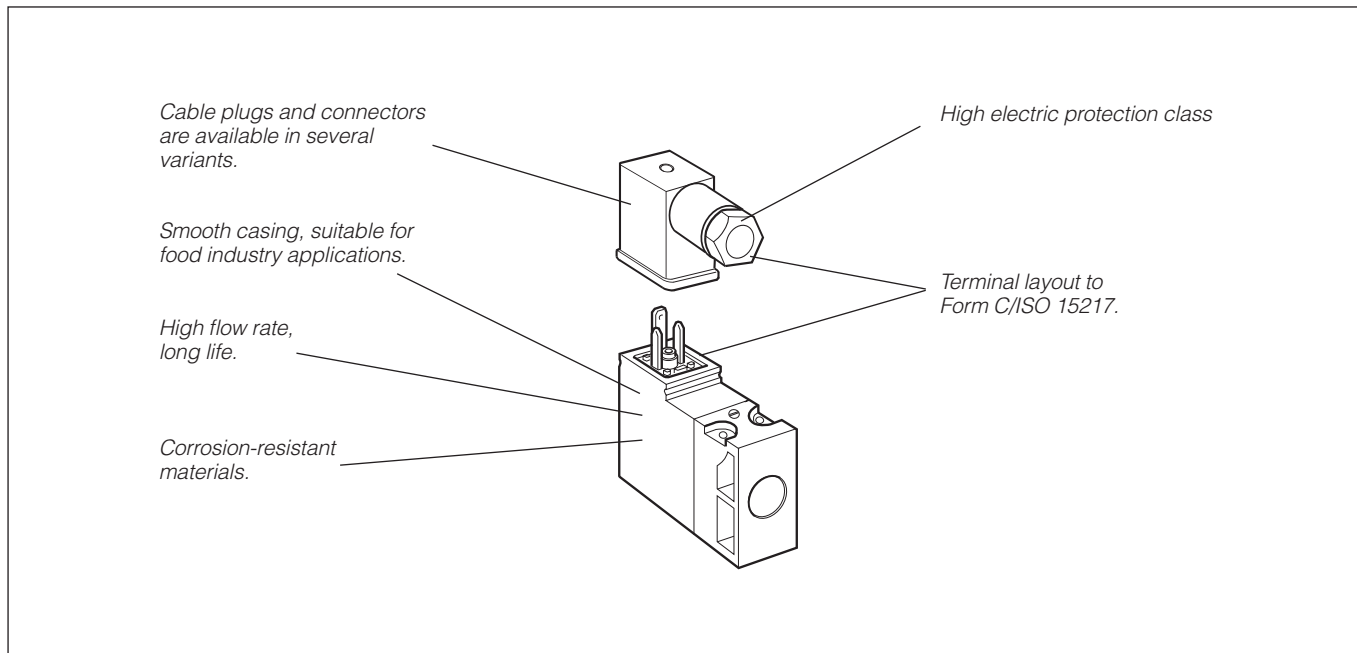

### The P2E-•V solenoid operator range

The P2E-•V range of operators are normally closed (NC) 3/2 solenoid valves, with exceedingly compact dimensions in relation to their capacity.

#### International standard

The port connection pattern complies with a new French CNOMO standard (in process of drafting), with cable plug connections in accordance with Form C/ISO15217.

#### Compact design

Overall dimensions of the P2E-•V operators are substantially less than those of earlier generations of solenoid operators.

#### High flow capacity

High flow capacity relative to the electrical operating power as a result of optimised internal flow paths.

#### Corrosion-resistant design

The valve is made of thermoplastic material and stainless steel, with Viton™ and nitrile rubber seals for excellent corrosion resistance.

#### Clean lines suitable for food industry applications, P2E-QV

The valve has been designed in conjunction with several machine manufacturers and organisations in the food processing industry, with corrosion-resistant materials and smooth lines being important starting points. The valve and its accessories have been designed so that there are no gaps or crevices in which dirt could collect.

#### High reliability

Few moving parts result in high reliability, rapid changeover and very long life.

#### Low power demand

The solenoids have a power demand of 1.2 W at 24 V DC and 1.6 VA at 24 V AC, 115 V AC and 230 V AC.

#### High protection class

The protection class is IP 65 when connected using the cable plug with a moulded cable. When using the standard cable plug for fitting by the user, the protection class is IP65, the bare valve, with Fast-on connectors, has an encapsulation class of IP 20.

#### Insensitive to dirty air

The use of generously sized flow paths (1.0 mm diameter) means that the valve can be used in normal industrial environments without problems of blocking.

#### Manual override as option

The operators can be supplied with or without manual override. The manual override device is available as a screwdriver groove or with a control arm, and is either spring return (blue) or lockable (yellow).

Order key, solenoid operators (15mm)

<b>P</b>	<b>2</b>	<b>E</b>	<b>-</b>	<b>Q</b>	<b>V</b>	<b>3</b>	<b>2</b>	<b>C</b>	<b>3</b>
----------	----------	----------	----------	----------	----------	----------	----------	----------	----------

Valve family	
<b>P2E</b>	Solenoid operator

Subfamily	
Solenoid operator, 15 mm wide Electric connection acc. to ISO 15217 Form C El/supply connection on opposite side	
<b>K</b>	Standard version
<b>M</b>	Mobile version
<b>Q</b>	Food industry version

Type of current	
<b>1</b>	AC 50 Hz
<b>2</b>	DC
<b>4</b>	AC 50/60 Hz
<b>5</b>	Mobile and wide band only

Voltage	
<b>B</b>	12 V
<b>C</b>	24 V
<b>D</b>	48 V
<b>F</b>	115 V*
<b>J</b>	230 V*
<b>W</b>	37,5 V**
<b>T</b>	72 V**
<b>Y</b>	78 V**
<b>V</b>	96 V**
<b>E</b>	110 V**

Overrides	
<b>0</b>	Without
<b>1</b>	Non locking (blue)
<b>2</b>	Locking (yellow)
<b>3</b>	Extended non locking (blue)
<b>4</b>	Extended locking (yellow)

Valvetype/Function	
<b>3</b>	 3/2 valve, normally closed (NC)

\* For standard and food type only  
\*\* For mobile "M" version only

Technical data

	NC, Standard	NC, Food <sup>1)</sup>	NC, Mobile <sup>2)</sup>
Working pressure	0 to 10 bar	0 to 10 bar	0 to 10 bar
Working temperature	-15 °C to +60 °C	-15 °C to +60 °C	-40 °C to +70 °C
Orifice	1,0 mm	1,0 mm	1,0 mm
Flow Qmax	33 Nl/min	33 Nl/min	22 Nl/min
Power, hold	DC 1,2 W / AC 1,6 VA *	DC 1,2 W / AC 1,6 VA *	DC 1,4 W
Power, surge	DC 1,2 W / AC 3,5 VA *	DC 1,2 W / AC 3,5 VA *	DC 1,4 W
Connection time	100%	100%	100%
Voltage tolerance	+10%/-15%	+10%/-15%	+25%/-30%
Electric connection:	Form C/ISO15217		
Port pattern:	To future CNOMO standard		
Protection:	IP 65		
Approval:	Some valves are UL 429 recognised and marked with the following symbol		
Working media:	All neutral media, such as compressed air, water, hydraulic oil and many gases.		
1) Design:	Completely smooth exterior, suitable for food industry.		
2) Mobile standard	According to European standard EN 50 155.		

\* Power , hold for 230VAC 2.4VA  
Power, surge for 230VAC 5.5VA

Transients

Interrupting the current through the solenoid coil produces momentary voltage peaks which, under unfavourable conditions, can amount to several hundred times the rated operating voltage. Normally, these transients do not cause problems, but to achieve the maximum life of relays in the circuit (and particularly of transistors, thyristors and integrated circuits) it is desirable to provide protection by means of voltage-dependent resistors (varistors). All cable plugs with a yellow LED also incorporate such protection.

Service life

With compressed air at 6 bar, 20 °C and complying with the requirements for compressed air quality as set out in ISO8573-1 norm (class 4 for dry and class 5 for filtered air), the valves should have a life of at least 50 million cycles.

Materials

Operator

Body, coil casing	Thermoplastic
Internal metal parts	Steel
Screws	Stainless steel
Bottom plug	Thermoplastic
Sealing materials	FPM (Viton™) and nitrile rubber

Cable head

Sheath	Thermoplastic
Retaining screw	Stainless steel, zinc-plated steel





**15mm Solenoid Operators**

Electrical connection EN175301-803 C/ISO15217 (Ex DIN 43650C)

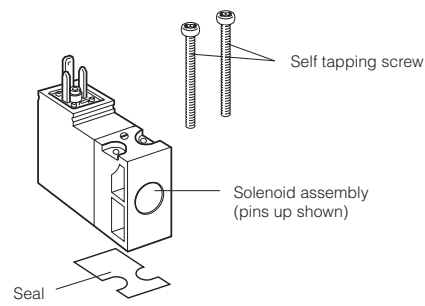

**Solenoids 15 mm NC, standard**

Voltage	Weight Kg	Order code		Weight Kg	Order code		Weight Kg	Order code	
		Without manual override	Override, blue, non locking flush		Override, blue, non locking flush	Override, yellow, locking flush			
 12 VDC 24 VDC 48 VDC 24 VAC 50Hz 48 VAC 50/60Hz 115 VAC 50Hz/ 120 VAC 60Hz 230 VAC 50Hz/ 240 VAC 60Hz	0,038	<b>P2E-KV32B0</b>		0,038	<b>P2E-KV32B1</b>		0,038	<b>P2E-KV32B2</b>	
	0,038	<b>P2E-KV32C0</b>		0,038	<b>P2E-KV32C1</b>		0,038	<b>P2E-KV32C2</b>	
	0,038	<b>P2E-KV32D0</b>		0,038	<b>P2E-KV32D1</b>		0,038	<b>P2E-KV32D2</b>	
	0,038	<b>P2E-KV31C0</b>		0,038	<b>P2E-KV31C1</b>		0,038	<b>P2E-KV31C2</b>	
	0,038	<b>P2E-KV34D0</b>		0,038	<b>P2E-KV34D1</b>		0,038	<b>P2E-KV34D2</b>	
	0,038	<b>P2E-KV31F0</b>		0,038	<b>P2E-KV31F1</b>		0,038	<b>P2E-KV31F2</b>	
	0,038	<b>P2E-KV31J0</b>		0,038	<b>P2E-KV31J1</b>		0,038	<b>P2E-KV31J2</b>	
 24 VDC 24 VAC 50Hz		Order code			Order code			Order code	
		Weight Kg	Without manual override	Override extended, non locking flush	Weight Kg	Override extended, locking flush	Weight Kg	Without manual override	Override extended, locking flush
	0,038	<b>P2E-KV32C3</b>		0,038	<b>P2E-KV32C4</b>		0,038	<b>P2E-KV31C3</b>	
	0,038	<b>P2E-KV31C3</b>		0,038	<b>P2E-KV31C4</b>				

**Solenoids 15 mm NC, mobile**

(Note! Mounting screws included in basic valve)

Voltage	Weight Kg	Order code		Weight Kg	Order code	
		Without manual override	Override, blue, non locking flush		Override, blue, non locking flush	Override, yellow, locking flush
 12 VDC 24 VDC 37,5 VDC 48 VDC 72 VDC 78 VDC 96 VDC 110 VDC	0,038	<b>P2E-MV35B0</b>		0,038	<b>P2E-MV35B1</b>	
	0,038	<b>P2E-MV35C0</b>		0,038	<b>P2E-MV35C1</b>	
	0,038	<b>P2E-MV35W0</b>		0,038	<b>P2E-MV35W1</b>	
	0,038	<b>P2E-MV35D0</b>		0,038	<b>P2E-MV35D1</b>	
	0,038	<b>P2E-MV35T0</b>		0,038	<b>P2E-MV35T1</b>	
	0,038	<b>P2E-MV35Y0</b>		0,038	<b>P2E-MV35Y1</b>	
	0,038	<b>P2E-MV35V0</b>		0,038	<b>P2E-MV35V1</b>	
	0,038	<b>P2E-MV35E0</b>		0,038	<b>P2E-MV35E1</b>	

**Solenoids 15 mm NC, food industry version**

(Note! Mounting screws included in basic valve)

Voltage	Weight Kg	Order code		Weight Kg	Order code		Weight Kg	Order code		
		Without manual override	Override, blue, non locking flush		Override, blue, non locking flush	Override, yellow, locking flush				
 24 VDC 48 VDC 24 VAC 50Hz 48 VAC 50/60Hz 115 V 50Hz/ 120 V 60Hz 230 VAC 50Hz/ 240 VAC 60Hz	0,038	<b>P2E-QV32C0</b>		0,038	<b>P2E-QV32C1</b>		0,038	<b>P2E-QV32C2</b>		
	0,038	<b>P2E-QV32D0</b>		0,038	<b>P2E-QV32D1</b>		0,038	<b>P2E-QV32D2</b>		
	0,038	<b>P2E-QV31C0</b>		0,038	<b>P2E-QV31C1</b>		0,038	<b>P2E-QV31C2</b>		
	0,038	<b>P2E-QV34D0</b>		0,038	<b>P2E-QV34D1</b>		0,038	<b>P2E-QV34D2</b>		
	0,038	<b>P2E-QV31F0</b>		0,038	<b>P2E-QV31F1</b>		0,038	<b>P2E-QV31F2</b>		
	0,038	<b>P2E-QV31J0</b>		0,038	<b>P2E-QV31J1</b>		0,038	<b>P2E-QV31J2</b>		
	0,038	<b>P2E-QV31J3</b>		0,038	<b>P2E-QV31J4</b>		0,038	<b>P2E-QV31J4</b>		
 24 VDC 24 VAC 50Hz 115 VAC 50 Hz 230 VAC 50 Hz		Order code			Order code			Order code		
		Weight Kg	Without manual override	Override extended, non locking flush	Weight Kg	Override extended, locking flush	Weight Kg	Without manual override	Override extended, locking flush	
		0,038	<b>P2E-QV32C3</b>		0,038	<b>P2E-QV32C4</b>		0,038	<b>P2E-QV31C3</b>	
		0,038	<b>P2E-QV31C3</b>		0,038	<b>P2E-QV31C4</b>		0,038	<b>P2E-QV31F3</b>	
		0,038	<b>P2E-QV31F3</b>		0,038	<b>P2E-QV31F4</b>		0,038	<b>P2E-QV31J3</b>	

In accordance with the EU Machine Directive, EN 983, solenoid valves with manual override should have spring-return operating arms for safety.



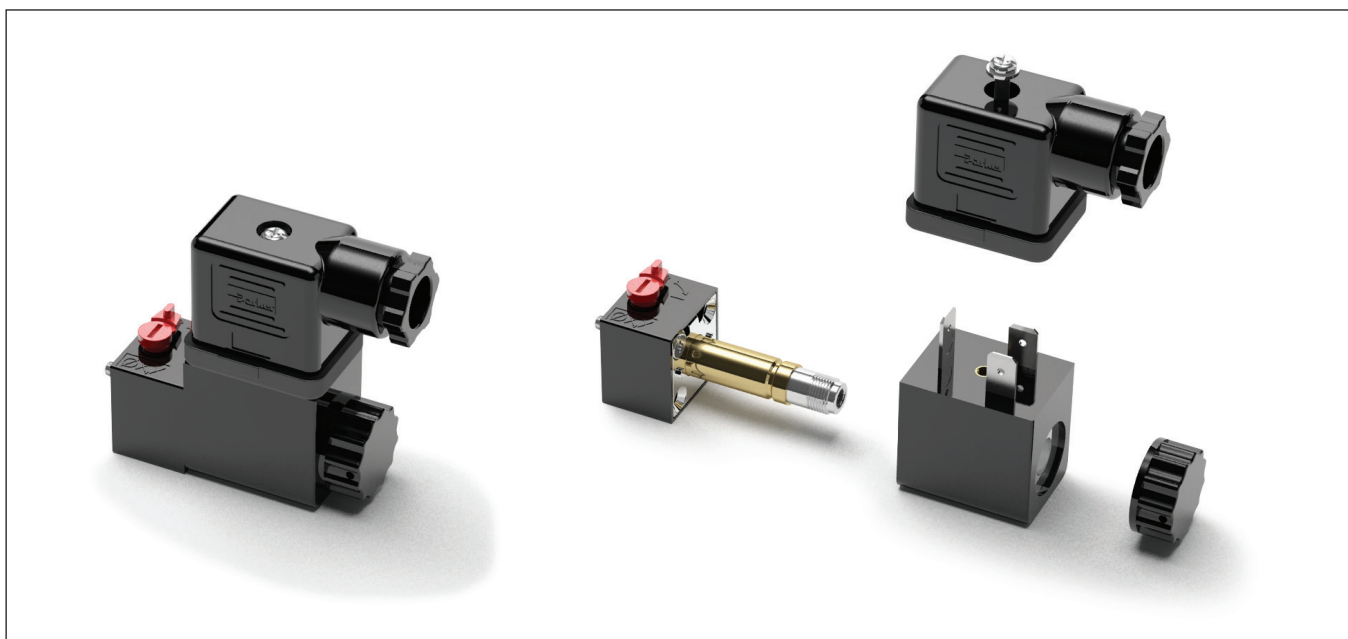

### 22mm Solenoid pilot options

The P2F P13\*4\* (NC) 3/2 solenoid pilot operators are designed for piloting pneumatic control valves with compressed air or other inert gases.

The P2F P operator is available for Normal operating pressures up to 10 bar having an outlet orifice 1.3mm and exhaust orifice 1.5 mm. An alternative operator is also available having an outlet orifice of 0.8mm and exhaust orifice of 1.0mm for Xtreme maximum operating pressure of 16 bar and wide band voltage tolerances required for mobile applications.

For hard environment, a metal operator (anodised aluminium) with brass manual override is available with a 1.2 mm outlet orifice and 1.3mm exhaust orifice. Different temperature range is covering inside, outside application.

### Corrosion resistant design

The pilot operator body is manufactured in thermoplastic PA 6 material and the core tube brass/stainless steel. The plunger/core is made from stainless steel and the valve seats from FKM.

### Mobile Applications

Viking Xtreme valves are tested to +5g shock and vibration. Solenoid operated valves are designed to operate with wide voltage tolerance bands within the ambient temperature ranges stated in the technical section.

### Solenoid Pilot Exhaust

These operators all exhaust out of the top of the core tube which is tapped M5. The standard solenoid nut fitted to the core tube is the Diffuser nut which allows the exhaust to escape to atmosphere. This nut also minimises ingress of dirt into the valve through this port. The alternative plastic knurled nut can be specified (refer to part number system) if the exhaust air needs to be captured and piped away using the M5 tapped port.

### Manual Override options

The pilot operators can be supplied with or without manual override. The standard manual override is the monostable (spring return) extended brass override. Alternatively the bistable (locking) override can be specified as an alternative for the Normal duty 10bar option.

### Coils

Coils are wound with enameled copper wire, having temperature index 180°C with class F insulation (155°C) and are encapsulated in Thermoplastic resin. When fitted with suitable connector and correct gasket they give protection to IP65.

### Spares

Solenoid operators are available as spares complete with mounting screws and seals. Coils and connectors should be ordered separately.



## Order key, solenoid operators (22mm)

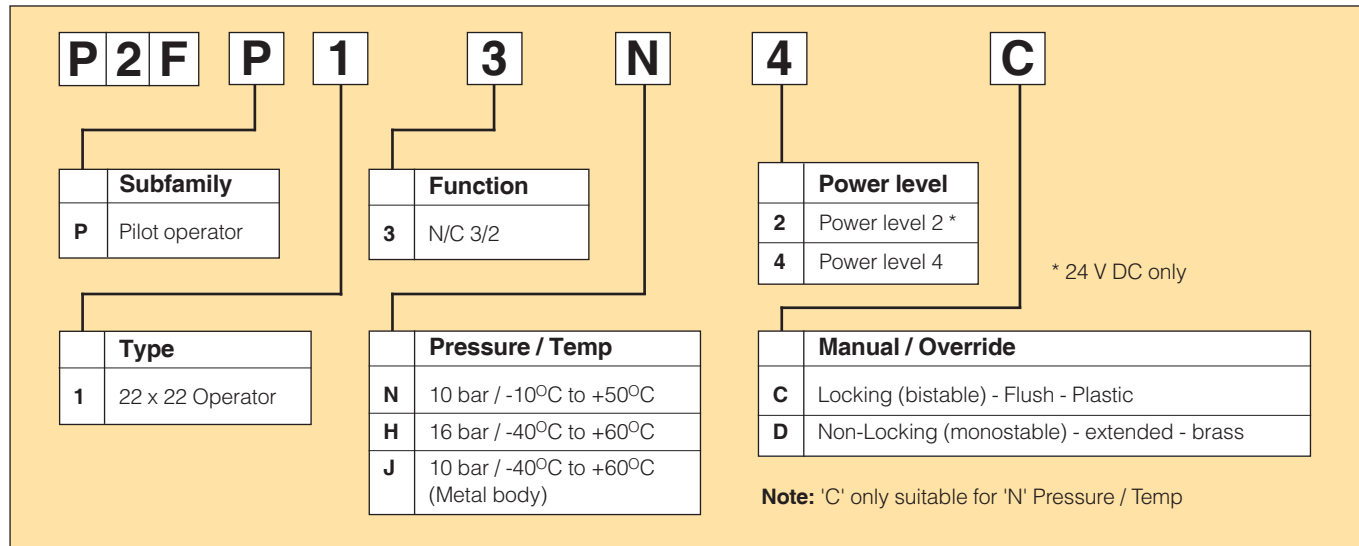

## Technical data

	NC Normal	NC Xtreme	NC 22mm Xtreme (Mobile)	NC 30mm Xtreme (Mobile)	NC 30 mm Metal (Mobile)
Working pressure	0 to 10 bar	0 to 16 bar	0 to 10 bar	0 to 16 bar	0 to 10 bar
Ambient temperature	-10 °C to +50 °C	-40 °C to +60 °C	-40 °C to +60 °C	-40 °C to +60 °C	-40 °C to +60 °C
Orifice	1.3/1.5mm	0.8/1.0mm	0.8/1.0mm	0.8/1.0mm	1,2 mm / 1,3mm
Flow Qn @ 6 bar input 1 bar press drop. 1-2 l/m	55	20	20	20	60
Flow Qn @ 6 bar input 1 bar press drop. 2-3 l/m	70	30	30	30	70
Power (DC)	4.8W (2W Low power)	4.8W	6.0W	6.8W	6.8W
Power (AC)	8.5VA	8.5VA			
Voltage tolerance (Standard)	+/- 10%	+/- 10%			
Voltage tolerance (Mobile)			-10 to +30%	+/- 30%	+/- 30%
Duty cycle	100%	100%	100%	100%	100%
Insulation class	F	F	F	F	F
Electric connection	Ind Form B	Ind Form B	Ind Form B	Form A	Form A
Protection	IP65	IP65	IP65	IP65	IP65
Shock & Vibration	-	0 to +5g	0 to +5g	0 to +5g	0 to 5g
Approval	UL coil version available on request				
Working media	All neutral media such as compressed air and inert gases.				

## Mobile applications

Solenoid operated Viking Xtreme duty valves for Mobile applications are fitted with the P2FP13H4D solenoid pilot operator. It has a 22mm footprint with 0.8/1.0mm orifice and will accept 22mm or 30mm coil options. The choice of coil option will depend on the voltage tolerance, operating ambient temperature range and maximum operating pressure. Use the technical data in the table above before selecting the coil type required, or contact our technical department.

## Transients

Interrupting the current through the solenoid coil produces momentary voltage peaks which, under unfavourable conditions, can amount to several hundred times the rated operating voltage. Normally, these transients do not cause problems, but to achieve the maximum life of relays in the circuit (and particularly of transistors, thyristors and integrated circuits) it is desirable to provide protection by means of voltage-dependent resistors (varistors). All connectors/cable plugs with LED's listed on page 54 include this type of circuit protection.

## Materials

## Pilot Valve

Body:	Polyamide
Body:	Anodised aluminium for J type
Armature tube:	Brass (Normal) Stainless Steel 16 bar mobile
Plunger & core:	Corrosion resistant Cr-Ni steel
Seals:	FKM (Viton™)
Screws:	Stainless steel

## Coil

Encapsulation material:	Thermoplastic
-------------------------	---------------

## 22mm solenoid operator part numbers and spares

## Solenoids coil standard 22mm

Voltage	Voltage tolerance	Temperature	Order code Form B	Power	Weight (Kg)	Use with Operator type
12V 50Hz	+/-10%	-10°C / 50°C	<b>P2FCB440</b>	8,5VA	0.053	P2FP13N4
24V 50/60Hz	+/-10%	-10°C / 50°C	<b>P2FCB442</b>	8,5VA	0.053	P2FP13N4
48V 50/60Hz	+/-10%	-10°C / 50°C	<b>P2FCB449</b>	8,5VA	0.053	P2FP13N4
120V/50Hz, 120V/60Hz	+/-10%	-10°C / 50°C	<b>P2FCB453</b>	8,5VA	0.053	P2FP13N4
230V/50Hz, 230V/60Hz	+/-10%	-10°C / 50°C	<b>P2FCB457</b>	8,5VA	0.053	P2FP13N4
12V DC	+/-10%	-10°C / 50°C	<b>P2FCB445</b>	4,8W	0.053	P2FP13N4
24V DC	+/-10%	-10°C / 50°C	<b>P2FCB449</b>	4,8W	0.053	P2FP13N4
48V DC	+/-10%	-10°C / 50°C	<b>P2FCB451</b>	4,8W	0.053	P2FP13N4

For pressure 0 to 10 bar

## Solenoids coil low power 22mm

Voltage	Order code Form B	Power	Weight (Kg)	Use with Operator type
24V DC Low power	<b>P2FCB249</b>	2W	0.093	P2FP13N2

For pressure 0 to 10 bar

## Solenoids coil 22mm Xtreme

Voltage	Voltage tolerance	Temperature	Order code Form B	Power	Weight (Kg)	Use with Operator type
12V 50Hz	+/-10%	-40°C / 60°C	<b>P2FCB440</b>	8,5VA	0.053	P2FP13NH4D
24V 50/60Hz	+/-10%	-40°C / 60°C	<b>P2FCB442</b>	8,5VA	0.053	P2FP13NH4D
48V 50/60Hz	+/-10%	-40°C / 60°C	<b>P2FCB449</b>	8,5VA	0.053	P2FP13NH4D
120V/50Hz, 120V/60Hz	+/-10%	-40°C / 60°C	<b>P2FCB453</b>	8,5VA	0.053	P2FP13NH4D
230V/50Hz, 230V/60Hz	+/-10%	-40°C / 60°C	<b>P2FCB457</b>	8,5VA	0.053	P2FP13NH4D
12V DC	+/-10%	-40°C / 60°C	<b>P2FCB445</b>	4,8W	0.053	P2FP13NH4D
24V DC	+/-10%	-40°C / 60°C	<b>P2FCB449</b>	4,8W	0.053	P2FP13NH4D
48V DC	+/-10%	-40°C / 60°C	<b>P2FCB451</b>	4,8W	0.053	P2FP13NH4D

For pressure 0 to 16 bar for A+B &amp; 12 bar for C+D

## Solenoids coil mobile voltage 22mm

Voltage	Voltage tolerance	Temperature	Order code Form B	Power	Weight (Kg)	Use with Operator type
12V DC	-10% / +30%	-40°C / + 60°C	<b>P2FCB447</b>	6W	0.053	P2FP13H4D
24V DC	-10% / +30%	-40°C / + 60°C	<b>P2FCB448</b>	6W	0.053	P2FP13H4D

For pressure 0 to 16 bar for A+B &amp; 12 bar for C+D

## Solenoids coil Mobile voltage 30mm

Voltage	Voltage tolerance	Temperature	Order code Form A	Power	Weight (Kg)	Use with Operator type
12V DC	+/- 30%	-40°C / +60°C	<b>P2FCA447</b>	6,8W	0.09	P2FP13H4D
24V DC	+/- 30%	-40°C / +60°C	<b>P2FCA448</b>	6,8W	0.09	P2FP13H4D
48V DC	+/- 30%	-40°C / +60°C	<b>P2FCA474</b>	6,8W	0.09	P2FP13H4D
72V DC	+/- 30%	-40°C / +60°C	<b>P2FCA470</b>	6,8W	0.09	P2FP13H4D
96V DC	+/- 30%	-40°C / +60°C	<b>P2FCA471</b>	6,8W	0.09	P2FP13H4D
110V DC	+/- 30%	-40°C / +60°C	<b>P2FCA472</b>	6,8W	0.09	P2FP13H4D

For pressure 0 to 16 bar for A+B &amp; 12 bar for C+D

## Solenoids coil Mobile voltage 30mm

Voltage	Voltage tolerance	Temperature	Order code Form A	Power	Weight (Kg)	Use with Operator type
12V DC	+/- 30%	-40°C / +60°C	<b>P2FCA447</b>	6,8W	0.09	P2FP13J4
24V DC	+/- 30%	-40°C / +60°C	<b>P2FCA448</b>	6,8W	0.09	P2FP13J4
48V DC	+/- 30%	-40°C / +60°C	<b>P2FCA474</b>	6,8W	0.09	P2FP13J4
72V DC	+/- 30%	-40°C / +60°C	<b>P2FCA470</b>	6,8W	0.09	P2FP13J4
96V DC	+/- 30%	-40°C / +60°C	<b>P2FCA471</b>	6,8W	0.09	P2FP13J4
110V DC	+/- 30%	-40°C / +60°C	<b>P2FCA472</b>	6,8W	0.09	P2FP13J4

For pressure 0 to 10 bar

## Spare Solenoid Nuts

Valves requiring captured exhaust should be fitted with plastic knurled nut

Order code
<b>P2FNP</b>

Valves with vented exhaust are fitted with diffuser plastic nut

Order Code
<b>P2FND</b>

## Spare Solenoid Operators

Solenoid pilot operator 22mm NC, Normal duty  
(Max Operating pressure 10bar, Temp -10°C to +50°C)

Order code (with locking bi-stable m/o)	weight Kg	Order code (with Non-locking monostable m/o)	weight Kg
<b>P2FP13N4C</b>	0.05kg	<b>P2FP13N4D</b>	0.05kg

Low power pilot operator NC, Normal duty  
(Max Operating pressure 10bar, Temp -10°C to +50°C)

Order code (with locking bi-stable m/o)	weight Kg	Order code (with Non-locking monostable m/o)	weight Kg
<b>P2FP13N2C</b>	0.05kg	<b>P2FP13N2D</b>	0.05kg

Solenoid pilot operator 22mm NC, Xtreme duty  
(Max Operating pressure 16bar, Temp -40°C to +60°C)

Order code (with Non-locking monostable m/o)	weight Kg
<b>P2FP13H4D</b>	0.05kg

Solenoid pilot operator 22mm NC Mobile metal  
(Max Operating pressure 10bar, Temp -40°C to +60°C)



Order code (with brass non locking m/o)	weight Kg	Order code (with brass locking m/o)	weight Kg	Order code No manual override	weight Kg
<b>P2FP13J4B</b>	0.04kg	<b>P2FP13J4C</b>	0.04kg	<b>P2FP13J4A</b>	0.04kg

**Note.**

Solenoid pilot operators are fitted to the Viking valve range. Order the above part numbers for spares. The operators are supplied with mounting screws and interface 'O' rings.

**Coils and connectors must be ordered separately.**

**Solenoid Connectors / Cable Plugs EN175301-803**

	Description	Order code 15mm Form C/ISO15217	Order code 22mm Industrial Form B	Order code 30mm Form A/ISO4400
With large headed screw suitable for mounting in inaccessible or recess position 	Standard IP65	<b>P8C-C</b>		
	24V DC LED and protection IP65	<b>P8C-C26C</b>		
	110V AC LED and protection IP65	<b>P8C-C21E</b>		
With standard screw 	Standard IP65 without flying lead	<b>P8C-D</b>	<b>3EV10V10</b>	<b>3EV290V10</b>
	With LED and protection 24V AC/DC	<b>P8C-D26C</b>	<b>3EV10V20-24</b>	<b>3EV290V20-24</b>
	With LED and protection 110V AC/DC	<b>P8C-D21E</b>	<b>3EV10V20-110</b>	<b>3EV290V20-110</b>
	With LED and protection 230V AC		<b>3EV10V20-230</b>	
With cable 	Standard with 2m cable IP65	<b>P8L-C2</b>		
	Standard with 5m cable IP65	<b>P8L-C5</b>		
	24V AC/DC, 2m cable LED and protection IP65	<b>P8L-C226C</b>		
	24V AC/DC, 5m cable LED and protection IP65	<b>P8L-C526C</b>	<b>3EV10V20-24L5</b>	<b>3EV290V20-24L5</b>
	24V AC/DC, 10m cable LED and protection IP65	<b>P8L-CA26C</b>		
	110V AC/DC, 2m cable LED and protection IP65	<b>P8L-C221E</b>		
	110V AC/DC, 5m cable LED and protection IP65	<b>P8L-C521E</b>	<b>3EV10V20-110L5</b>	
	230V AC, 5m cable LED and protection IP65		<b>3EV10V20-230L5</b>	

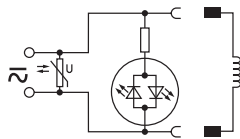
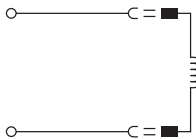

<b>P8C-C</b>	<b>P8C-D26C</b>	<b>P8L-C226C</b>
<b>P8C-D</b>	<b>P8C-D21E</b>	<b>P8L-C526C</b>
<b>P8L-C2</b>	<b>P8C-C26C</b>	<b>P8L-CA26C</b>
<b>P8L-C5</b>	<b>P8C-C21E</b>	<b>P8L-C221E</b>
<b>3EV10V10</b>		<b>P8L-C521E</b>
<b>3EV290V10</b>	<b>3EV10V20-24</b>	<b>3EV10V20-24L5</b>
	<b>3EV10V20-110</b>	<b>3EV10V20-110L5</b>
	<b>3EV10V20-230</b>	<b>3EV10V20-230L5</b>



Cable Plug Dimensions (mm)

Solenoid operators P2E-•V...

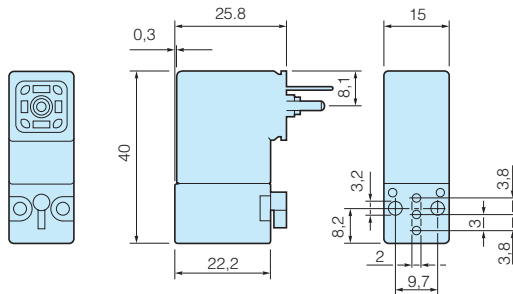

Solenoid operators P2FP...

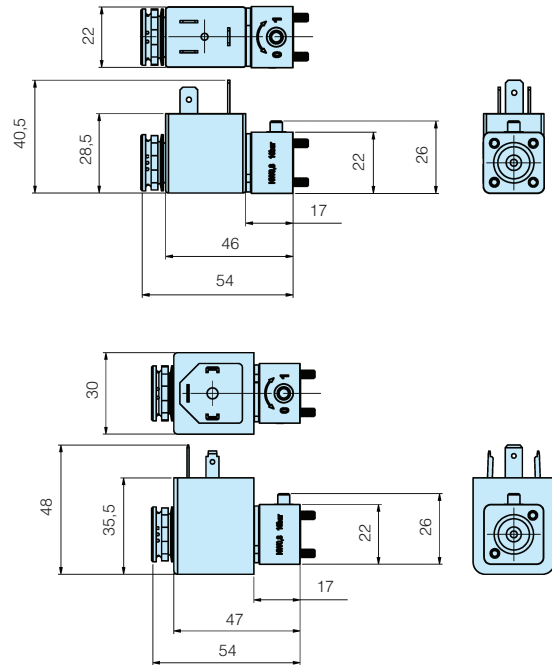

Cable plugs

- P8C-C
- P8C-C26C
- P8C-C21E
- P8C-D
- P8C-D26C
- P8C-D21E

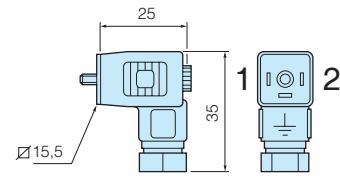

Cable plugs with cables

- P8L-C2
- P8LC5
- P8L-C226C
- P8L-C526C
- P8L-CA26C
- P8L-C221E
- P8L-C521E

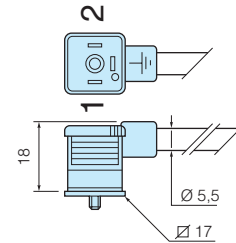

Cable plugs Form B

- 3EV10V10
- 3EV10V20-24
- 3EV10V20-110
- 3EV10V20-230
- 3EV10V20-24L5
- 3EV10V20-110L5
- 3EV10V20-230L5

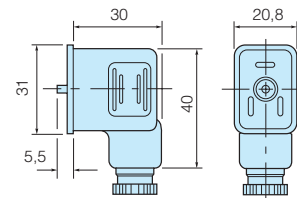

Cable plugs Form A

- 3EV290V10
- 3EV290V20-24
- 3EV290V20-24L5

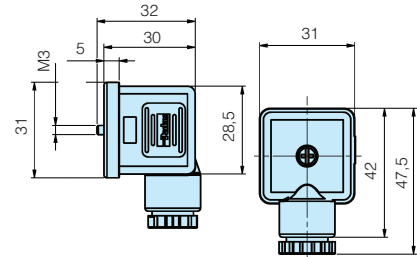

Accessories

Sintered bronze series

Port	Order code	Pack Qty
M5	9721900005	1
G1/8	9090050700	1
G1/4	P6M-BAA2	1
G3/8	9090050900	1
G1/2	9090051000	1

Male straight connectors - Parallel thread

Tube Ø1	Thread B	Order code	Box Qty
4	1/8	F4PMB4-1/8	20
6	1/8	F4PMB6-1/8	30
6	1/4	F4PMB6-1/4	30
8	1/8	F4PB8-1/8	40
8	1/4	F4PB8-1/4	30
8	3/8	F4PB8-3/8	20
10	1/4	F4PB10-1/4	20
10	3/8	F4PB10-3/8	20
10	1/2	F4PB10-1/2	10
12	1/4	F4PB12-1/4	10
12	3/8	F4PB12-3/8	10
12	1/2	F4PB12-1/2	10
14	3/8	F4PB14-3/8	10
14	1/2	F4PB14-1/2	10



# Parker Worldwide

## Europe, Middle East, Africa

**AE – United Arab Emirates,**  
Dubai

Tel: +971 4 8127100  
parker.me@parker.com

**AT – Austria,** Wiener Neustadt

Tel: +43 (0)2622 23501-0  
parker.austria@parker.com

**AT – Eastern Europe,** Wiener  
Neustadt

Tel: +43 (0)2622 23501 900  
parker.easteurope@parker.com

**AZ – Azerbaijan,** Baku

Tel: +994 50 2233 458  
parker.azerbaijan@parker.com

**BE/LU – Belgium,** Nivelles

Tel: +32 (0)67 280 900  
parker.belgium@parker.com

**BG – Bulgaria,** Sofia

Tel: +359 2 980 1344  
parker.bulgaria@parker.com

**BY – Belarus,** Minsk

Tel: +375 17 209 9399  
parker.belarus@parker.com

**CH – Switzerland,** Etoy

Tel: +41 (0)21 821 87 00  
parker.switzerland@parker.com

**CZ – Czech Republic,** Klecany

Tel: +420 284 083 111  
parker.czechrepublic@parker.com

**DE – Germany,** Kaarst

Tel: +49 (0)2131 4016 0  
parker.germany@parker.com

**DK – Denmark,** Ballerup

Tel: +45 43 56 04 00  
parker.denmark@parker.com

**ES – Spain,** Madrid

Tel: +34 902 330 001  
parker.spain@parker.com

**FI – Finland,** Vantaa

Tel: +358 (0)20 753 2500  
parker.finland@parker.com

**FR – France,** Contamine s/Arve

Tel: +33 (0)4 50 25 80 25  
parker.france@parker.com

**GR – Greece,** Athens

Tel: +30 210 933 6450  
parker.greece@parker.com

**HU – Hungary,** Budaörs

Tel: +36 23 885 470  
parker.hungary@parker.com

**IE – Ireland,** Dublin

Tel: +353 (0)1 466 6370  
parker.ireland@parker.com

**IT – Italy,** Corsico (MI)

Tel: +39 02 45 19 21  
parker.italy@parker.com

**KZ – Kazakhstan,** Almaty

Tel: +7 7273 561 000  
parker.easteurope@parker.com

**NL – The Netherlands,** Oldenzaal

Tel: +31 (0)541 585 000  
parker.nl@parker.com

**NO – Norway,** Asker

Tel: +47 66 75 34 00  
parker.norway@parker.com

**PL – Poland,** Warsaw

Tel: +48 (0)22 573 24 00  
parker.poland@parker.com

**PT – Portugal,** Leca da Palmeira

Tel: +351 22 999 7360  
parker.portugal@parker.com

**RO – Romania,** Bucharest

Tel: +40 21 252 1382  
parker.romania@parker.com

**RU – Russia,** Moscow

Tel: +7 495 645-2156  
parker.russia@parker.com

**SE – Sweden,** Spånga

Tel: +46 (0)8 59 79 50 00  
parker.sweden@parker.com

**SL – Slovenia,** Novo Mesto

Tel: +386 7 337 6650  
parker.slovenia@parker.com

**TR – Turkey,** Istanbul

Tel: +90 216 4997081  
parker.turkey@parker.com

**UA – Ukraine,** Kiev

Tel: +380 44 494 2731  
parker.poland@parker.com

**UK – United Kingdom,** Warwick

Tel: +44 (0)1926 317 878  
parker.uk@parker.com

**ZA – South Africa,** Kempton Park

Tel: +27 (0)11 961 0700  
parker.southafrica@parker.com

## North America

**CA – Canada,** Milton, Ontario

Tel: +1 905 693 3000

**US – USA,** Cleveland

Tel: +1 216 896 3000

## Asia Pacific

**AU – Australia,** Castle Hill

Tel: +61 (0)2-9634 7777

**CN – China,** Shanghai

Tel: +86 21 2899 5000

**HK – Hong Kong**

Tel: +852 2428 8008

**IN – India,** Mumbai

Tel: +91 22 6513 7081-85

**JP – Japan,** Tokyo

Tel: +81 (0)3 6408 3901

**KR – South Korea,** Seoul

Tel: +82 2 559 0400

**MY – Malaysia,** Shah Alam

Tel: +60 3 7849 0800

**NZ – New Zealand,** Mt Wellington

Tel: +64 9 574 1744

**SG – Singapore**

Tel: +65 6887 6300

**TH – Thailand,** Bangkok

Tel: +662 186 7000

**TW – Taiwan,** Taipei

Tel: +886 2 2298 8987

## South America

**AR – Argentina,** Buenos Aires

Tel: +54 3327 44 4129

**BR – Brazil,** Sao Jose dos Campos

Tel: +55 12 4009 3500

**CL – Chile,** Santiago

Tel: +562 2303 9640

**MX – Mexico,** Toluca

Tel: +52 72 2275 4200

European Product Information Centre

Free phone: 00 800 27 27 5374

(from AT, BE, CH, CZ, DE, DK, EE, ES, FI,  
FR, IE, IL, IS, IT, LU, MT, NL, NO, PL, PT, RU,  
SE, SK, UK, ZA)



### Parker Hannifin Ltd.

Tachbrook Park Drive  
Tachbrook Park,  
Warwick, CV34 6TU  
United Kingdom  
Tel.: +44 (0) 1926 317 878  
Fax: +44 (0) 1926 317 855  
parker.uk@parker.com  
www.parker.com

Your local authorized Parker distributor